

VZP45N

Material del fregadero

Syntech

Tipo

Cubeta de composite

Número de cubetas

1

Código EAN

8017709294137



Estética



Estética

Universal

Color

Negro

Serie

Quadra

Tipo de empotrado

Estándar, Bajo encimera

Logo

Otros colores disponibles

Agujero para grifo /
Agujero para grifo precortado

En el rebosadero

Gris, Blanco, Cemento /
Hormigón

No agujero

	Tipología cubeta	Dimensiones cubeta , L x P x A (mm)	Profundidad cubeta (mm)	Radio angular cubeta	Demasiado lleno cubeta	Posición descarga cubeta	Dimensión descarga cubeta
Cubeta	Rayada	400 x 400 x 215	215	10	Sí, alineado	De pared	3.5"

Características técnicas



Characteristics composite material

Cubeta, Fácil de limpiar, Sifón con conexión para lavavajillas, Resistente al choque térmico, Ganchos montaje, Junta, Resistente a los rayos UV

Dimensiones del producto (mm)

215x456x456 mm

Dimensiones hueco instalación sobre encimera (mm)

446x446 mm

Altura desde encimera de la cocina

6 mm

Medida mueble empotrable

45, 50 cm

Número de ganchos

4

Tipología ganchos

Estándar + clip bajo encimera

Dimensiones hueco instalación bajo encimera (mm) 400x400 mm

Radio angular orificio de empotrado 10 mm

Equipo accesorios incluidos

Equipo accesorios montaje Cubeta, Sifón con conexión para lavavajillas, Ganchos montaje

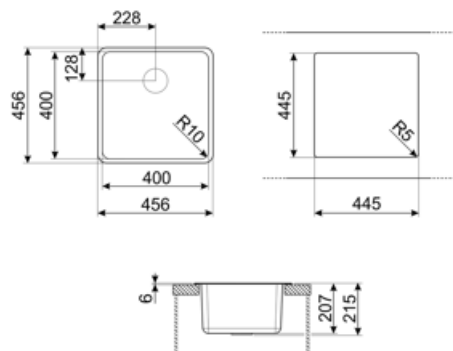

Compatible Accessories



CB25MN

Single HPE chopping board to fit minimum radius bowls, black matt, measures 250 x 410 H 12 mm, dishwasher safe



COL19

St/Steel colander to fit MINIMUM radius mm bowl, measures 200 x 410 x 26 mm



COL36

St/steel colander for MINIMUM radius bowls, measures 370 x 410 x 30 mm



KITFD050

Triturador de residuos 0,5 HP, Motor: 1/2 caballo de potencia, Se adapta a todos los fregaderos con salida de residuos de 3 1/2"



KITFD100

Triturador de residuos 1 HP, Motor: 1/2 caballo de potencia, compatible con todos los fregaderos con salida de desagüe de 3 1/2".



CB28QU

Single HPL chopping board for minimum radius, oak, measures 280 x 418 H 12 mm



COL19H

St/Steel colander to fit MINIMUM radius mm bowl, measures 200 x 410 x 100 mm



KITDSQ

Soap dispenser chrome finishing with square knob 40x40 mm



KITFD075

Triturador de residuos 0,75 HP, Motor: 1/2 caballo de potencia, compatible con todos los fregaderos con salida de desagüe de 3 1/2".

Alternative products















VZP45B
Color: Blanco



VZP45CT
Color: Cemento

Symbols glossary

	Antibacterial		Antiscratch
	Tamaño del mueble base: Se requiere el tamaño del mueble base para la instalación del fregadero.		Cupboard width required for sink installation
	Indica la profundidad de la cubeta del fregadero		Estándar: método de instalación, que se adapta fácilmente a cualquier tipo de cocina.
	Undermount: cómo instalar el fregadero o la placa directamente debajo de la superficie de trabajo, lo que le permite aprovechar toda la superficie disponible.		Fácil de limpiar
	High temperatures resistant		Impact resistant
	Resistente al choque térmico		UV protection, does not fade over time.

Benefit (TT)

Una tarja

Una sola tarja para mayor adaptabilidad, capacidad y optimización del espacio