

# VZP56B

Material der Spüle                      Granit  
Beckenart                                 Composite-Spüle  
Anzahl der Spülbecken                1  
EAN-Code                                8017709294052



## Ästhetik



**Ästhetik**                                Neutral  
**Serie**                                    Quadra  
**Farbe**                                    Weiß

**Montageart**                            Auflage, Unterbau  
**Markenlogo**                           On overflow  
**Weitere Farbvarianten**             Dove Gray, Schwarz,  
  Cemento / Concrete

	Art des Beckens	Abmessungen Becken BxTxH (mm)	Tiefe Becken (mm)	Eckradius Becken	Beckenüberlauf	Position Beckenablauf	Korbventil
Becken	Minimalradius	500 x 400 x 215	215	10	Beckenbündig	Hinten	3 ½"

## Technische Eigenschaften



**Characteristics composite material**     Antibakteriell, leicht zu reinigen, Siphon mit Schlauchanschluss, Siphon platzsparend mit Schlauchanschluß, Befestigungshaken, Dichtung, UV-Resistent

**Randhöhe**                                6 mm  
**Nischenmaß**                             60 cm  
**Anzahl der Befestigungshaken**        4  
**Art der Befestigungshaken**             Auflage + Unterbau

**Abmessungen der Spüle HxBxT (mm)**    215x556x456 mm

**Abmessungen Ausschnitt BxT (mm)**     546x446 mm

---

Ausschnittmaß für Unterbau	500x400 mm
Eckradius des Ausschnitts (R)	10 mm

## Serienzubehör

---

**Serien-Montagezubehör** Ab- und Überlaufgarnitur, Siphon mit Schlauchanschluss, Befestigungshaken

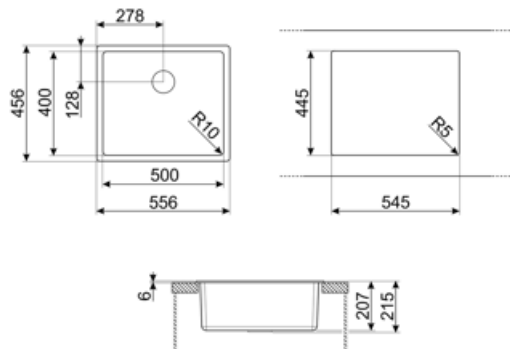

## Sonderzubehör



### KITFD050

Waste disposal 0,5 HP, Motor: 1/2 horsepower, Fits all sinks with 3 1/2" waste outlet



### KITFD100

Zerkleinerer von Küchenabfällen für Spülbecken mit 3 1/2" Korbventil.  
TECHNISCHE DATEN: Leistung: 1,0 PS, 2800 U/min, max. Leistungsaufnahme 550 W, Spannung/Frequenz 220-240V/50Hz~1N, Gewicht netto 4,7 kg  
Hinweis: Zerkleinerer von weichen organischen Küchen



### COL19

Abtropfbecken gelocht aus Edelstahl mit Kunststoffecken, kompatibel für Becken mit Minimalradius. Abmessungen LxBxH: 410x200x26 mm



### CB25MN

HPE-Schneidebrett in Schwarz-Matt, spülmaschineneignet, kompatibel für Becken mit Minimalradius. Abmessungen LxBxH: 410x250x12 mm



### CB28QU

HPE-Schneidebrett in Oak, kompatibel für Becken mit Minimalradius. Abmessungen LxBxH: 418 x 280 x 12 mm.



### COL36

Abtropfbecken gelocht aus Edelstahl mit Kunststoffecken, kompatibel für Becken mit Minimalradius. Abmessungen LxBxH: 418x280x12 mm



### COL19H

Abtropfbecken gelocht aus Edelstahl mit Kunststoffecken, kompatibel für Becken mit Minimalradius. Abmessungen LxBxH: 410x200x100 mm



### KITDSQ

Einbau-Seifenspender, Chrom, eckige Bauform, Hahnlochbohrung Ø 35 mm (Montage in Armaturenbank oder Arbeitsplatte)













### KITFD075

Waste disposal 0,75 HP, Motor: 1/2 horsepower, Fits all sinks with 3 1/2" waste outlet

---

## Symbols glossary (TT)

---

	Cupboard width required for sink installation		Sink depth - depending on the model, the depth can be from 13 to 24,5
	Standardeinbau: Klassische aufgesetzte Montage auf der Arbeitsplatte.		Under table top installation: The sink is fixed under tabletop, which extends the work surface and the depth of the sink.
	Antibakteriell		Antiscratch
	Termal schock resistant		High temperatures resistant
	Impact resistant		Easy to clean
	UV protection, does not fade over time.		

---

## Benefit (TT)

---

### **One bowl**

A single bowl for greater adaptability, capacity and space optimisation