

# VZP56B

Sink material Composite  
 Sink type Composite bowl  
 No. of bowls 1  
 EAN code 8017709294052



## Aesthetics



<b>Series</b>	Quadra	<b>Logo</b>	On overflow
<b>Aesthetics</b>	Universal	<b>Alternative colours available</b>	Dove Grey, Black, Cemento / Concrete
<b>Colour</b>	White	<b>Tap hole / precut tap hole</b>	No Taphole
<b>Building in type</b>	Standard, Undermount		

	Bowl type	Bowl dimensions, WxDxH (mm)	Bowl depth (mm)	Radius corner bowl	Overflow	Strainer position	Strainer dimension
Bowl	Minimum radius	500 x 400 x 215	215	10	Yes, flush fitted	Wall position	3.5"

## Technical Features



<b>Characteristics composite material</b>	Strainer, Siphon with dishwasher outlet connection, Siphon save space with dishwasher outlet connection, Fixing clips, Gasket, Pre-assembled gasket, UV Resistant	<b>Height from kitchen top</b>	6 mm
		<b>Base unit size</b>	60 cm
		<b>No. of clips</b>	4
		<b>Type of clips</b>	Standard + undermount clip
<b>Dimensions of the product (mm)</b>	215x556x456 mm		
<b>Cutout dimension (mm)</b>	546x446 mm		

---

Cutout dimension undermount (mm)	500x400 mm
Cutout radius	10 mm

## Accessories Included

---

Accessories for installation	Strainer, Siphon with dishwasher outlet connection, Fixing clips
---------------------------------	--

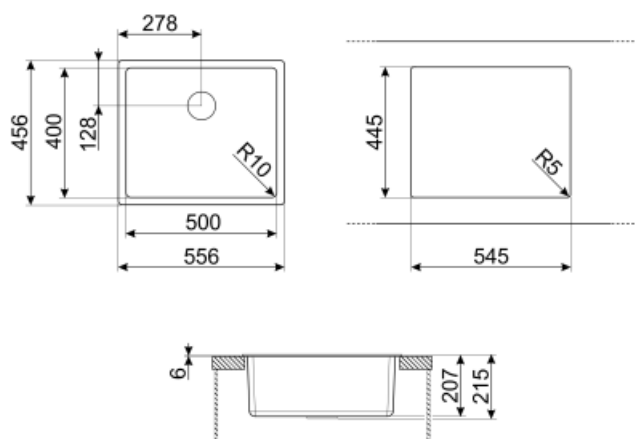

## Not included accessories



### KITFD050

Waste disposal 0,5 HP Motor: 1/2 horsepower Fits all sinks with 3 1/2" waste outlet



### KITFD100

Waste disposal 1 HP Motor: 1 horsepower Fits all sinks with 3 1/2" waste outlet



### COL19H

St/Steel colander to fit MINIMUM radius mm bowl, measures 200 x 410 x 100 mm



### KITDSQ

Soap dispenser Square knob



### KITFD075

Waste disposal 0,75 HP Motor: 3/4 horsepower Fits all sinks with 3 1/2" waste outlet



### DBSINT34

Drain Basket for composite sink



### COL36

St/steel colander for MINIMUM radius bowls, measures 370 x 410 x 30 mm



### MATROL

Stainless steel drainer 405 x 340 mm



### COL19

St/Steel colander to fit MINIMUM radius mm bowl, measures 200 x 410 x 26 mm



### CB25MN

Single HPE chopping board to fit minimum radius bowls, black matt, measures 250 x 410 H 12 mm, dishwasher safe



### KITFD050UK

Waste disposal 0,5 HP Motor: 1/2 horsepower Fits all sinks with 3 1/2" waste outlet

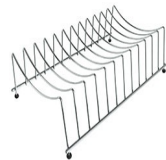

### COLPTX

Drainer accessory













### CB28QU

Single HPL chopping board for minimum radius, oak, measures 280 x 418 H 12 mm

---

## Symbols glossary

---

	Cupboard width required for sink installation		Sink depth - depending on the model, the depth can be from 13 to 24,5
	Standard installation: Traditional installation in tabletop, suitable for any kitchen sets		Under table top installation: The sink is fixed under tabletop, which extends the work surface and the depth of the sink.
	Antibacterial		Antiscratch
	Thermal shock resistant		High temperatures resistant
	Impact resistant		Easy to clean
	UV protection, does not fade over time.		