

VZP76CT

Sink material	Composite
Type	Synthetic bowl
No. of bowls	1
EAN code	8017709294021



Aesthetics



Aesthetic	Universal	Logo	On overflow
Serie	Quadra	Alternative colours available	Dove Gray, Black, White
Colour	Cement / Concrete	Half bowl cup drainer	No
Building in type	Standard, Undermount	Tap hole / precut tap hole	No Taphole

	Bowl type	Bowl dimensions, WxDxH (mm)	Bowl depth (mm)	Radius corner bowl	Overflow	Strainer position	Strainer dimension
Bowl	Minimum radius	700 x 400 x 215	215	10	Yes, flush fitted	Wall position	3.5"

Technical Features



Características do material composto	Válvula de escoamento, Fácil de limpar, Sifão com ligação à máquina de lavar louça, Resistente a choques térmicos, Ganchos de fixação, Vedantes, Resistente a UV	Base unit size	80 cm
Dimensions of the product (mm)	215x756x456 mm	Tap hole	No
Cutout dimension topmount (mm)	746x446 mm	Popup command	No
		Pre-assembled gasket	No
		No. of clips	4
		Type of clips	Clip padrão + subtopo

Dimensão do recorte sob a montagem (mm)	700x400 mm
Cutout radius	10 mm
Height from kitchen top	6 mm

Accessories Included

Accessories for installation	Strainer, Siphon with dishwasher outlet connection, Fixing clips	Glass board	No
Colander	No	Basket	No
Rondò Cover waste kit	No	Wooden board	No
Kit de resíduos Tampa de aço inox quadrada	No	White board	No

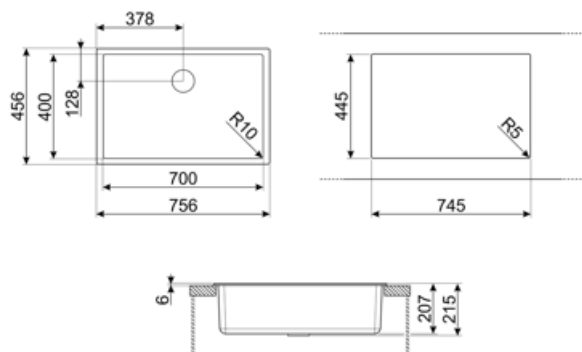

Compatible Accessories



CB25MN

Tábua única de corte HPE para caber em tigelas de raio mínimo, fosca preta, mede 250 x 410 H 12 mm, pode ir à máquina lava-louça



COL19

Coador aço inox para encaixar na tigela de raio MÍNIMO mm, mede 200 x 410 x 26 mm



COL36

Coador de aço para tigelas de raio mínimo, mede 370 x 410 x 30 mm



KITFD050

Eliminação de resíduos 0,5 CV Motor: 1/2 cv Serve para todas as pias com saída de resíduos de 3 1/2"



KITFD100

Eliminação de resíduos 1 CV Motor: 1 cv Serve para todas as pias com saída de resíduos de 3 1/2"



CB28QU

Tábua única de corte HPL para raio mínimo, carvalho, mede 280 x 418 H 12 mm



COL19H

Coador aço inox para encaixar na tigela de raio MÍNIMO mm, mede 200 x 410 x 100 mm



KITDSQ











Botão quadrado do dispensador de sabão



KITFD075

Eliminação de resíduos 0,75 CV Motor: 3/4 CV Adapta-se a todas as pias com saída de resíduos de 3 1/2"

Symbols glossary

	Largura do armário necessária para a instalação da pia		Profundidade da pia - dependendo do modelo, a profundidade pode ser de 13 a 24,5
	Instalação padrão: Instalação tradicional em tampo de mesa, adequado para qualquer conjunto de cozinha		Instalação sob o tampo da mesa: A pia é fixada sob o tampo da mesa, que estende a superfície de trabalho e a profundidade da pia.
	Antisséptico		Antirrisco
	Resistente a choques térmicos		Resistente a altas temperaturas
	Resistente a impactos		Fácil de limpar
	A proteção UV, não se desvanece com o tempo.		

Benefit (TT)

One bowl

A single bowl for greater adaptability, capacity and space optimisation