

VZP76N

Sink material Composite
 Type Composite bowl
 No. of bowls 1
 EAN code 8017709294038



Aesthetics



Aesthetic	Universale	Logo	On overflow
Colour	Black	Alternative colours available	Dove Gray, White, Cemento / Concrete
Series	Quadra	Tap hole / precut tap hole	No Taphole
Building in type	Standard, Undermount		

	Bowl type	Bowl dimensions, WxDxH (mm)	Bowl depth (mm)	Radius corner bowl	Overflow	Strainer position	Strainer dimension
Bowl	Minimum radius	700 x 400 x 215	215	10	Yes, flush fitted	Wall position	3.5"

Technical Features



Characteristics composite material	Antibacterial, Easy to clean, Anti-scratch , Termal schock resistant, High temperatures resistant, Impact resistant, UV Resistant	Height from kitchen top	6 mm
		Base unit size	80 cm
		No. of clips	4
		Type of clips	Standard + undermount clip
Dimensions of the product (mm)	215x756x456 mm		
Cutout dimension topmount (mm)	746x446 mm		

Cutout dimension undermount (mm)	700x400 mm
Undermount cutout radius	10 mm

Accessories included

Accessories for installation	Strainer, Savespace siphon with dishwasher outlet connection, Fixing clips
---------------------------------	--

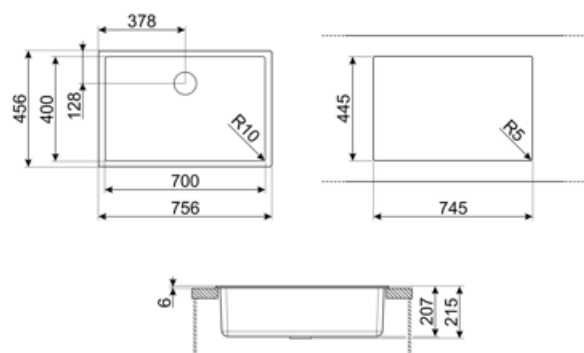

Compatible Accessories



CB25MN

Single HPE chopping board to fit minimum radius bowls, black matt, measures 250 x 410 H 12 mm, dishwasher safe



COL19

St/Steel colander to fit MINIMUM radius mm bowl, measures 200 x 410 x 26 mm



COL36

St/steel colander for MINIMUM radius bowls, measures 370 x 410 x 30 mm



KITFD050

Waste disposal 0,5 HP, Motor: 1/2 horsepower, Fits all sinks with 3 1/2" waste outlet



KITFD100

Waste disposal 1 HP, Motor: 1/2 horsepower, Fits all sinks with 3 1/2" waste outlet



CB28QU

Single HPL chopping board for minimum radius, oak, measures 280 x 418 H 12 mm



COL19H

St/Steel colander to fit MINIMUM radius mm bowl, measures 200 x 410 x 100 mm



KITDSQ

Soap dispenser chrome finishing with square knob 40x40 mm



KITFD075

Waste disposal 0,75 HP, Motor: 1/2 horsepower, Fits all sinks with 3 1/2" waste outlet

Alternative products

VZP76B

Colour: White



VZP76DV

Colour: Dove Gray













VZP76CT

Colour: Cement / Concrete



Symbols glossary

	Antibacterial		Antiscratch
	Cupboard width required for sink installation.		Sink depth - depending on the model, the depth can be from 13 to 24,5.
	Standard installation: Traditional installation in tabletop, suitable for any kitchen sets.		Under table top installation: The sink is fixed under tabletop, which extends the work surface and the depth of the sink.
	Easy to clean		High temperatures resistant
	Impact resistant		Thermal shock resistant
	UV protection, does not fade over time.		

Benefit (TT)

One bowl

A single bowl for greater adaptability, capacity and space optimisation