

# VZP76N

Material del fregadero	Granito
Tipología	Cubeta de composite
Número de cubetas	1
Código EAN	8017709294038



## Estética



Estética	Universal	Logo	On overflow
Serie	Quadra	Otros colores disponibles	Gris, Blanco, Cemento / Concrete
Color	Negro	Agujero para grifo / Agujero para grifo precortado	No agujero
Tipo de instalación	Estándar, Bajo encimera		

	Tipología cubeta	Dimensiones cubeta , L x P x A (mm)	Profundidad cubeta (mm)	Radio angular cubeta	Rebosadero	Posición filtro	Dimensión filtro
Cubeta	Rayada	700 x 400 x 215	215	10	Sí, alineado	De pared	3.5"

## Características técnicas



Characteristics composite material	Cubeta, Sifón con conexión para lavavajillas, Termal schock resistant, Ganchos montaje, Junta, Easy to clean, UV Resistant	Altura desde encimera de la cocina	6 mm
Dimensiones del producto (mm)	215x756x456 mm	Medida mueble empotrable	80 cm
Dimensiones hueco instalación sobre encimera (mm)	746x446 mm	Número de ganchos	4
		Tipología ganchos	Standard + undermount clip

Dimensiones hueco 700x400 mm  
instalación bajo  
encimera (mm)

Radio angular orificio de 10 mm  
empotrado

## Equipo accesorios incluidos

Equipo accesorios  
montaje Cubeta, Sifón con conexión  
para lavavajillas, Ganchos  
montaje

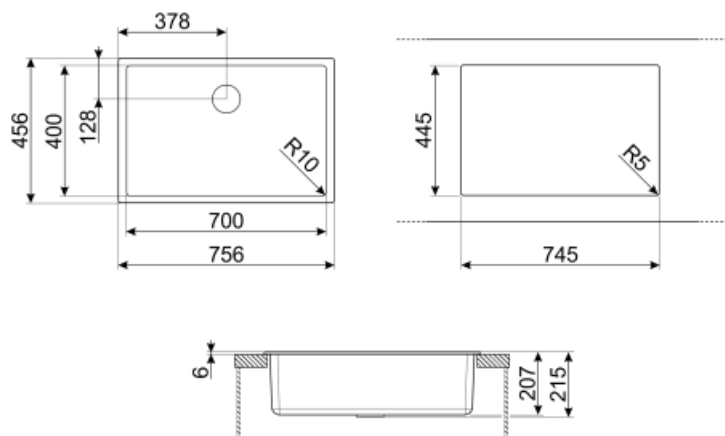

## Not included accessories



### KITFD050

Triturador de residuos 0,5 HP, Motor: 1/2 caballo de potencia, Se adapta a todos los fregaderos con salida de residuos de 3 1/2



### KITFD100

Waste disposal 1 HP, Motor: 1/2 horsepower, Fits all sinks with 3 1/2" waste outlet



### COL19

St/Steel colander to fit MINIMUM radius mm bowl, measures 200 x 410 x 26 mm



### CB25MN

Single HPE chopping board to fit minimum radius bowls, black matt, measures 250 x 410 H 12 mm, dishwasher safe



### CB28QU

Single HPL chopping board for minimum radius, oak, measures 280 x 418 H 12 mm



### COL36

St/steel colander for MINIMUM radius bowls, measures 370 x 410 x 30 mm



### COL19H

St/Steel colander to fit MINIMUM radius mm bowl, measures 200 x 410 x 100 mm



### KITDSQ











Soap dispenser chrome finishing with square knob 40x40 mm



### KITFD075

Waste disposal 0,75 HP, Motor: 1/2 horsepower, Fits all sinks with 3 1/2" waste outlet

## Symbols glossary (TT)

	Tamaño del mueble base: Se requiere el tamaño del gabinete base para la instalación del fregadero.		Indica la profundidad de la cubeta del fregadero
	Estándar: método de instalación, que se adapta fácilmente a cualquier tipo de cocina.		Undermount: cómo instalar el fregadero o la placa directamente debajo de la superficie de trabajo, lo que le permite aprovechar toda la superficie disponible.
	Antibacterial		Antiscratch
	Termal schock resistant		High temperatures resistant
	Impact resistant		Easy to clean
	UV protection, does not fade over time.		