

# VZUM40CT

Sink material	Composite
Type	Synthetic bowl
No. of bowls	1
EAN code	8017709251864



## Aesthetics



<b>Aesthetic</b>	Universal	<b>Logo</b>	On overflow
<b>Serie</b>	Quadra	<b>Alternative colours available</b>	Black, White, Cream, Beige, EXTRA White, EXTRA Black
<b>Colour</b>	Cement / Concrete	<b>Half bowl cup drainer</b>	No
<b>Building in type</b>	Undermount	<b>Tap hole / precut tap hole</b>	No Taphole

	Bowl type	Bowl dimensions, WxDxH (mm)	Bowl depth (mm)	Radius corner bowl	Overflow	Strainer position	Strainer dimension
Bowl	Minimum radius	340 x 400 x 210	210	5	Yes, traditional	Wall position	3.5"

## Technical Features



<b>Características do material composto</b>	Válvula de escoamento, Fácil de limpar, Sifão com ligação à máquina de lavar louça, Resistente a choques térmicos, Ganchos de fixação, Vedantes, Resistente a UV	<b>Diâmetro do furo da torneira</b>	35 mm
<b>Dimensions of the product (mm)</b>	210x380x440 mm	<b>Popup command</b>	No
<b>Dimensão do recorte sob a montagem (mm)</b>	340 X 400 mm	<b>Gasket type</b>	Sealing paste
		<b>Pre-assembled gasket</b>	No
		<b>No. of clips</b>	6
		<b>Type of clips</b>	Standard

<b>Cutout radius</b>	5 mm
<b>Base unit size</b>	45 cm
<b>Tap hole</b>	No

## Accessories Included

<b>Accessories for installation</b>	Strainer, Fixing clips	<b>Basket</b>	No
<b>Colander</b>	No	<b>Wooden board</b>	No
<b>Rondò Cover waste kit</b>	No	<b>White board</b>	No
<b>Glass board</b>	No		

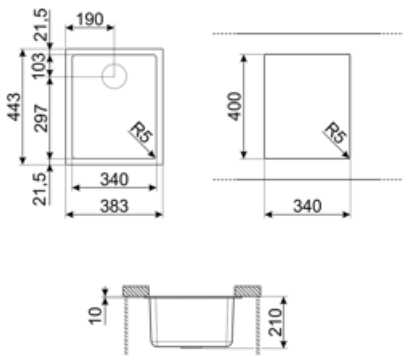

## Compatible Accessories



**3712**

Pias de bacia única sifão (conexão da máquina lava-louça incluída)



**3713**

Sifão bacias duplas pias (conexão da máquina lava-louça incluída)



**CB28QU**

Tábua única de corte HPL para raio mínimo, carvalho, mede 280 x 418 H 12 mm



**KITDS**

Botão redondo dispensador de sabão



**KITDSQ**

Botão quadrado do dispensador de sabão



**KITFD050**

Eliminação de resíduos 0,5 CV Motor: 1/2 cv Serve para todas as pias com saída de resíduos de 3 1/2"



**KITFD075**

Eliminação de resíduos 0,75 CV Motor: 3/4 CV Adapta-se a todas as pias com saída de resíduos de 3 1/2"



**KITFD100**











Eliminação de resíduos 1 CV Motor: 1 cv Serve para todas as pias com saída de resíduos de 3 1/2"



**KITPOPUP2**

1 kit automático de resíduos com botão quadrado para pias compostas UNIVERSAL

## Symbols glossary

	Antisséptico		Antirrisco
	Largura do armário necessária para a instalação da pia		Profundidade da pia - dependendo do modelo, a profundidade pode ser de 13 a 24,5
	Instalação sob o tampo da mesa: A pia é fixada sob o tampo da mesa, que estende a superfície de trabalho e a profundidade da pia.		Fácil de limpar
	Resistente a choques térmicos		Resistente a altas temperaturas
	Resistente a impactos		A proteção UV, não se desvanece com o tempo.

---

## Benefit (TT)

---

### **One bowl**

A single bowl for greater adaptability, capacity and space optimisation