

VZUM57CT

Sink material Composite
 Type Synthetic bowl
 No. of bowls 1
 EAN code 8017709251857



Aesthetics



Aesthetic	Universal	Logo	Applied
Serie	Quadra	Alternative colours available	Black, White, Cream, Beige, Cemento / Concrete, EXTRA White, EXTRA Black
Colour	Cement / Concrete	Half bowl cup drainer	No
Building in type	Undermount	Tap hole / precut tap hole	No Taphole

	Bowl type	Bowl dimensions, WxDxH (mm)	Bowl depth (mm)	Radius corner bowl	Overflow	Strainer position	Strainer dimension
Bowl	Minimum radius	500 x 400 x 210	210	5	Yes, traditional	Wall position	3.5"

Technical Features



Características do material composto

Válvula de escoamento, Fácil de limpar, Sifão com ligação à máquina de lavar louça, Resistente a choques térmicos, Ganchos de fixação, Vedantes, Resistente a UV

Diâmetro do furo da torneira 35 mm

Popup command No

Pre-assembled gasket No

No. of clips 6

Type of clips Standard

Dimensions of the product (mm) 215x540x440 mm

Dimensão do recorte sob a montagem (mm)	500 x 400 mm
Cutout radius	5 mm
Base unit size	60 cm
Tap hole	No

Accessories Included

Accessories for installation	Strainer, Fixing clips	Basket	No
Colander	No	Wooden board	No
Rondò Cover waste kit	No	White board	No
Glass board	No		

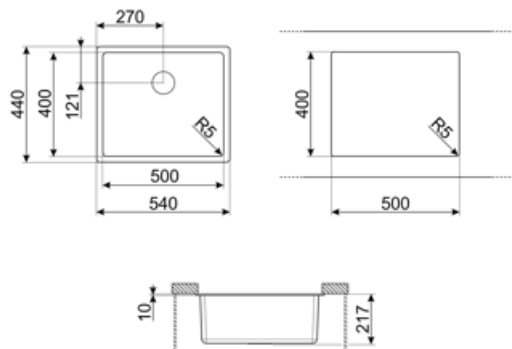

Compatible Accessories



3712

Pias de bacia única sifão (conexão da máquina lava-louça incluída)



3713

Sifão bacias duplas pias (conexão da máquina lava-louça incluída)



KITDS

Botão redondo dispensador de sabão



KITDSQ

Botão quadrado do dispensador de sabão



KITFD050

Eliminação de resíduos 0,5 CV Motor: 1/2 cv Serve para todas as pias com saída de resíduos de 3 1/2"



KITFD075

Eliminação de resíduos 0,75 CV Motor: 3/4 CV Adapta-se a todas as pias com saída de resíduos de 3 1/2"



KITFD100











Eliminação de resíduos 1 CV Motor: 1 cv Serve para todas as pias com saída de resíduos de 3 1/2"



KITPOPUP2

1 kit automático de resíduos com botão quadrado para pias compostas UNIVERSAL

Symbols glossary

	Antisséptico		Antirrisco
	Largura do armário necessária para a instalação da pia		Profundidade da pia - dependendo do modelo, a profundidade pode ser de 13 a 24,5
	Instalação sob o tampo da mesa: A pia é fixada sob o tampo da mesa, que estende a superfície de trabalho e a profundidade da pia.		Fácil de limpar
	Resistente a choques térmicos		Resistente a altas temperaturas
	Resistente a impactos		A proteção UV, não se desvanece com o tempo.

Benefit (TT)

One bowl

A single bowl for greater adaptability, capacity and space optimisation