









# WDF12C7-1

EAN Code	8017709161897
Product Family	Washer dryer
Commercial width	60 cm
Commercial depth	Standard capacity
Installation	Free-standing
Load type	Frontal



## Programs / Functions

Controls	Electronic
Programmes graphics	Written in EN
No. of programmes	15
Programmes	

 Cotton	 Cotton ECO
 Quick wash 15 min	 Drain + Spin
 Wool	 <i>Mix</i> Sport
 Mix	 Shirts
 Synthetics	 Delicates
 Rinse + Spin	 Clean
 Normal drying	 Delicate drying
 Night	

### Washing Temperature

Cool	30°C
40°C	60°C
75°C	90°C

### Special programmes

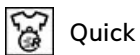

Special Clean programme, to remove residual fluff      Yes

### Display

Residual time indicator      delay start

Recommended load indicator      programme status indication

### Display type



### Buttons/Options

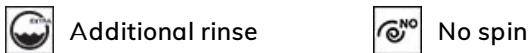

Programme progress indicator (light)      On display

End of cycle indicator (light)      On display

## Technical Features



Type of motor	Standard
Electronic control functioning	Yes
Programme selection knob	Yes

Door diameter	30 cm
Door opening	110°
Automatic variable load	Yes
Antifoam system	Yes
Load balancing system	Automatic

<b>Spin speed selection on display/LED</b>	No spin/ 500/ 600/ 800/ 1000/ 1200	<b>Easy to access filter</b>	Yes
<b>Display/led for temperature regulation</b>	Yes	<b>Child lock (functions block)</b>	Control block
<b>Polypropilene tank</b>	Yes	<b>Anti-flood system</b>	Yes
<b>Basket</b>	Stainless steel	<b>Water supply</b>	Single, cold
<b>Drum capacity</b>	52 l		
<b>Liquid detergent accessory as standard</b>	Yes		

## Performance / Energy Label









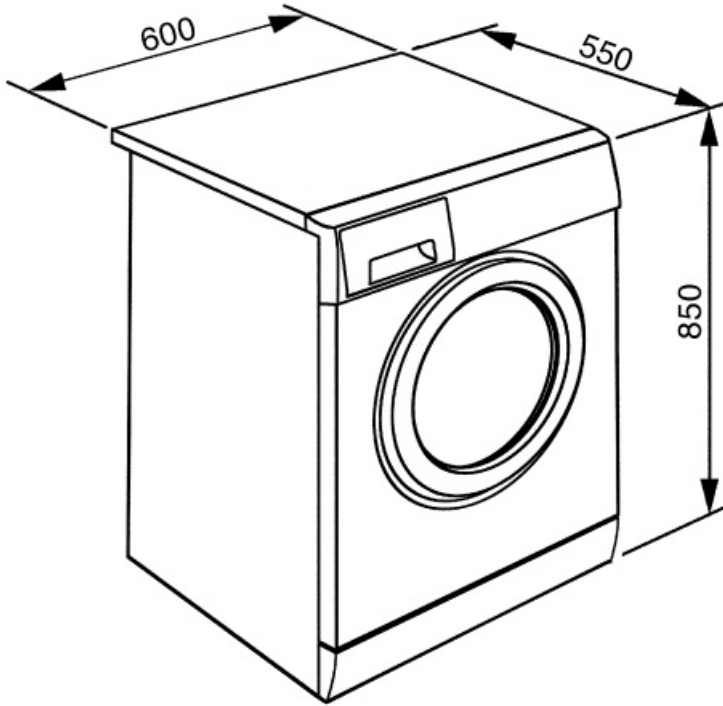









<b>Washing loading capacity</b>	7 kg	<b>Energy consumption (washing + drying)</b>	5.44 KWh
<b>Drying loading capacity</b>	4 kg	<b>Water consumption (washing) per cycle</b>	47 l
<b>Max spin speed</b>	1200 giri/min	<b>Water consumption (washing+drying) per cycle</b>	103 l
<b>Energy efficiency class</b>	B	<b>Duration of the normative programme</b>	410 min
<b>Washing efficiency class</b>	A	<b>Energy annual consumption (washing)</b>	238 KWh
<b>Energy rating</b>	BA	<b>Energy annual consumption (washing+drying)</b>	1088 KWh
<b>Noise level washing</b>	59 dB(A) re 1pW	<b>Water annual consumption (washing)</b>	9400 l
<b>Noise level spinning</b>	72 dB(A) re 1pW	<b>Water annual consumption (washing+drying)</b>	20600 l
<b>Noise level drying</b>	60 dB(A) re 1pW	<b>Residual humidity percentage (%)</b>	55 %
<b>Energy consumption - Cotton 60° - Wash only</b>	1.19 KWh		

















## Performance / Energy Label - Reg. 2019

<b>Supplier's name or trademark</b>	SMEG
-------------------------------------	------



## Symbols glossary (TT)

 <p><b>Easy Iron:</b> this is an option which can be selected to ensure the finished laundry is left with less creases to make ironing easier.</p>	 <p><b>Variable load:</b> In all models of washing machines is present the system of variable load, according to which the machine automatically diversifies the wash cycle and the time of operation depending on the quantity and type of laundry introduced, allowing a significant saving of water and energy power, up to 30% compared to the versions with fixed load.</p>
 <p><b>Automatic Load Balancing:</b> provides an ideal distribution of laundry in the drum. In case if the imbalance is detected, the rotation speed starts being controlled in such way to evenly redistribute laundry in the drum, and thus reduce vibration.</p>	 <p><b>Child lock:</b> some models are fitted with a device to lock the programme/cycle so it cannot be accidentally changed.</p>
 <p><b>Cold wash</b></p>	 <p><b>Delay timer:</b> can be set to run the programme at a convenient time or to take advantage of off-peak energy periods.</p>
 <p><b>LED display:</b> to show programmes, functions and options selected and the time to the end of the cycle.</p>	 <p><b>30 cm:</b> Large loading hatch of 30-32-33 cm in diameter, makes laundry loading and unloading easier and faster with maximum ease of use.</p>
 <p><b>B:</b> Product energy rating, measured from A+++ to D / G depending on the product family.</p>	 <p><b>Gentle drying:</b> program designed to get laundry ready for easy ironing.</p>
 <p>This shows the amount of laundry that can be inserted into the tumble dryer in KG.</p>	 <p>This option advises when the periodic cleaning of the filters is needed, in order to avoid forgetfulness and thus guarantee the perfect functioning of the dryer over time. The convenient position of the filters makes maintenance fast and extremely simple.</p>
 <p><b>Intensive:</b> this option intensifies the selected program. Cycle duration and water consumption are reduced by taking into account the type of laundry, while still guaranteeing excellent washing results, even in the case of stains that are difficult to eliminate.</p>	 <p><b>No spin option:</b> this option allows to exclude the last spin phase, draining the water from the tank</p>
 <p><b>Prewash:</b> program designed for heavily soiled garments.</p>	 <p><b>Cleaning programme:</b> A cleaning programme has been created to maintain the performance of washer/dryers. The display shows automatically when cleaning is required.</p>

- |   |   |
|---|---|
|  <p>Cotton: For soiled fabrics in cotton</p>  |  <p>Use to wash your normally soiled, durable cotton and linen laundry. Although it washes longer than all other programmes, it provides high energy and water savings. Actual water temperature may be different from the stated wash temperature. When you load the machine with less laundry (e.g. ½ capacity or less), programme time may automatically get shorter. In this case, energy and water consumption will decrease more, providing a more economic wash. This programme is available in the models with the remaining time indicator.</p> |
|  <p>Delicate: Clothing such as underwear, hosiery and luxury fabrics should be dried on the delicate cycle to help extend the life of the clothing.</p>   |  <p>To drain the water in the machine.</p>   |
|  <p>Program designed for clothes that have to be stored or used immediately.</p>  |  <p>Extra Rinse: Extra Rinse: adds an extra rinse cycle to that already provided in the program chosen, to remove any residual detergent. This function is particularly suitable for those with allergies or skin problems.</p>  |
|  <p>Mixed fabrics: this cycle is designed for lightly soiled laundry in a mix of cottons and synthetics, or can be used just to refresh stored items.</p> |  <p>Night: an ideal programme for those who want to take advantage of off-peak energy periods, this cycle is particularly quiet due to slower rotations of the drum.</p>   |
|  <p>Super fast 15 min: a programme designed to wash small amounts of laundry fast, ideal for washing lightly soiled garments.</p>                       |  <p>Super fast: a programme designed to wash small amounts of laundry fast, ideal for washing lightly soiled garments.</p>   |
|  <p>To drain the water into the basket + centrifuge action</p>  |  <p>Shirts: a cycle to wash shirts in a short time with the utmost care, using a delicate spin for easy ironing.</p>   |
|  <p>Gym: Gym, a cycle designed for washing lightly soiled garments, ie sports wear, this is a fast wash which is also kind to fabrics.</p>              |  <p>Synthetics: to wash your synthetic clothes (shirts, blouses, synthetic/cotton blends, etc.). It washes with a gentle action and has a shorter washing cycle compared to the Cottons programme. For curtains and tulle, use the Synthetic 40°C programme with prewash and anti-creasing functions selected. As their meshed texture causes excessive foaming, wash the veils/tulle by putting little amount of detergent into the main wash compartment. Do not put detergent in the prewash compartment.</p>                                       |
|  <p>Wool: this programme for wool or delicate fabrics uses slower rotations of the drum to ensure the utmost care for clothing.</p>                     |  <p>Option that allow to reduce times of the selected program.</p>   |
|  <p>Drum has maximum capacity of 7kg of dry laundry.</p>  |   |