

WDF14C7SSA

EAN Code	8017709261610
Product Family	Washer dryer
Commercial width	60 cm
Commercial depth	Standard capacity
Installation	Free-standing
Load type	Frontal



Programmes

Controls	Electronic
Programmes graphics	Written in EN
Multilanguage clip system	
Languages clip	
No. of programmes	15
Programmes	

 Cotton	 Cotton ECO	 Clean
 Delicate drying	 Delicates	 Drain + Spin
 Mix	 Night	 Normal drying
 Quick wash 15 min	 Rinse + Spin	 Shirts
 Sport	 Synthetics	 Wool

Washing Temperature

Cool	30°C	40°C
60°C	75°C	90°C

Special programmes

 Shirts	 Wool	 Mix
 Quick 15 min	 Sport	

Special Clean programme, to remove residual fluff Yes

Woolmark Code

Display

Residual time indicator delay start programme status indication

spin regulation temperature regulation

Display type



Buttons/Options

 Delay timer	 FlexiTime	 Prewash
 Additional rinse	 No spin	 Rinse hold
 Anti-wrinkle (easy ironing)	 Intensive	 Cold wash
 Drying		

Programme progress indicator (light)

On display

End of cycle indicator (light)



Technical Features



Effective consumption

Type of motor	Standard
Electronic control functioning	Yes
Programme selection knob	Yes
Spin speed selection on display/LED	600/ 800/ 1000/ 1200/ 1400/ No
Display/led for temperature regulation	Yes
Polypropilene tank	Yes
Basket	Stainless steel
Drum capacity	54 l
Liquid detergent accessory as standard	Yes
Door diameter	30 cm
Door opening	180°

Automatic variable load	Yes
Antifoam system	Yes
Load balancing system	Automatic
Easy to access filter	Yes
Resistencia Life Plus	
Child lock (functions block)	Control block
Anti-flood system	Yes
Autocleaning system	Yes
Water supply	Single, cold
Accessories included	
Furniture door can be fitted on right or left side with adjustable hinges	

Performance / Energy Label









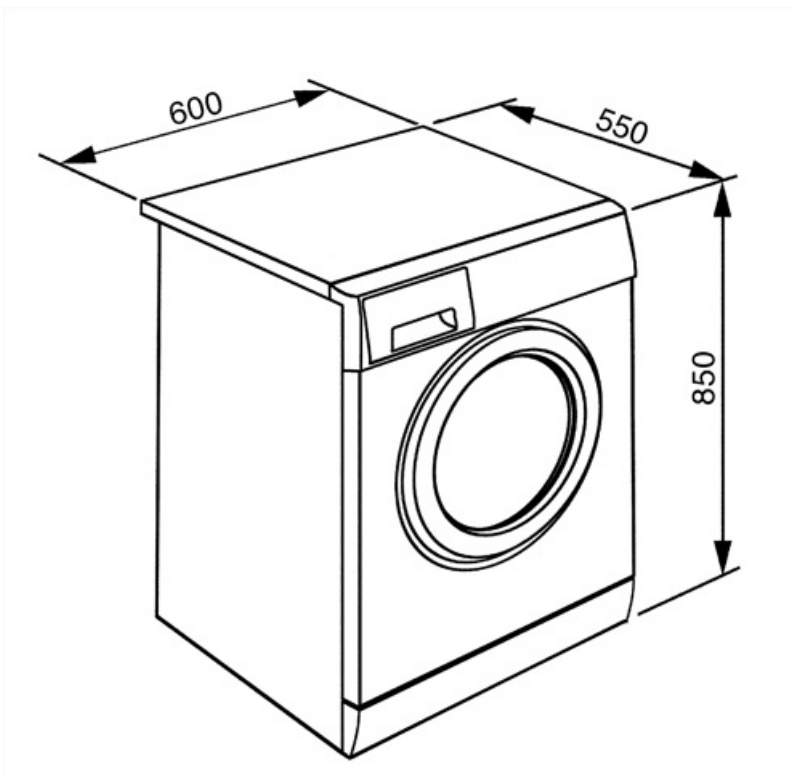













Washing loading capacity	7 kg	Energy consumption (washing + drying)	5,6 KWh
Drying loading capacity	4 kg	Water consumption (washing) per cycle	49 l
Max spin speed	1400 rpm	Water consumption (washing+drying) per cycle	89 l
Energy efficiency class	B	Duration of the normative programme	420 min.
Washing efficiency class	A	Energy annual consumption (washing)	260 KWh
Energy rating	BA	Energy annual consumption (washing+drying)	1120 KWh
Noise level washing	59 dB(A) re 1 pW	Water annual consumption (washing)	9800 l
Noise level spinning	75 dB(A) re 1 pW	Water annual consumption (washing+drying)	17800 l
Noise level drying	61 dB(A) re 1 pW	Residual humidity percentage (%)	50 %
Energy consumption - Cotton 60° - Wash only	1,3 KWh		















Performance / Energy Label

Supplier's name or trademark SMEG



Symbols glossary

 <p>Easy Iron: this is an option which can be selected to ensure the finished laundry is left with less creases to make ironing easier.</p>	 <p>Variable load: In all models of washing machines is present the system of variable load, according to which the machine automatically diversifies the wash cycle and the time of operation depending on the quantity and type of laundry introduced, allowing a significant saving of water and energy power, up to 30% compared to the versions with fixed load.</p>
 <p>Autocleaning system: Autocleaning system avoids the formation of lint and impurities inside the condensation system ensuring maximum reliability of the machine</p>	 <p>Automatic Load Balancing: provides an ideal distribution of laundry in the drum. In case if the imbalance is detected, the rotation speed starts being controlled in such way to evenly redistribute laundry in the drum, and thus reduce vibration.</p>
 <p>Acoustic signal: informs about the end of the drying cycle, in order to to get things out in time and avoid excessive creasing.</p>	 <p>Child lock: some models are fitted with a device to lock the programme/cycle so it cannot be accidentally changed.</p>
 <p>Cold wash</p>	 <p>Delay timer: can be set to run the programme at a convenient time or to take advantage of off-peak energy periods.</p>
 <p>B: Product energy rating, measured from A+++ to D / G depending on the product family.</p>	 <p>LED display: to show programmes, functions and options selected and the time to the end of the cycle.</p>
 <p>30 cm: Large loading hatch of 30-32-33 cm in diameter, makes laundry loading and unloading easier and faster with maximum ease of use.</p>	 <p>Gentle drying: program designed to get laundry ready for easy ironing.</p>
 <p>This shows the amount of laundry that can be inserted into the tumble dryer in KG.</p>	 <p>This option advises when the periodic cleaning of the filters is needed, in order to avoid forgetfulness and thus guarantee the perfect functioning of the dryer over time. The convenient position of the filters makes maintenance fast and extremely simple.</p>
 <p>FlexiTime: The FlexiTime option allows the user to reduce the time of the cycle selected, providing extra flexibility and control.</p>	 <p>Intensive: this option intensifies the selected program. Cycle duration and water consumption are reduced by taking into account the type of laundry, while still guaranteeing excellent washing results, even in the case of stains that are difficult to eliminate.</p>
 <p>No spin option: this option allows to exclude the last spin phase, draining the water from the tank</p>	 <p>Prewash: program designed for heavily soiled garments.</p>
 <p>Cleaning programme: A cleaning programme has been created to maintain the performance of washer/dryers. The display shows automatically when cleaning is required.</p>	 <p>Cotton: For soiled fabrics in cotton</p>

-  Use to wash your normally soiled, durable cotton and linen laundry. Although it washes longer than all other programmes, it provides high energy and water savings. Actual water temperature may be different from the stated wash temperature. When you load the machine with less laundry (e.g. ½ capacity or less), programme time may automatically get shorter. In this case, energy and water consumption will decrease more, providing a more economic wash. This programme is available in the models with the remaining time indicator.
-  To drain the water in the machine.
-  Extra Rinse: Extra Rinse: adds an extra rinse cycle to that already provided in the program chosen, to remove any residual detergent. This function is particularly suitable for those with allergies or skin problems.
-  Night: an ideal programme for those who want to take advantage of off-peak energy periods, this cycle is particularly quiet due to slower rotations of the drum.
-  Terminato il lavaggio il ciclo si blocca con l'acqua in vasca
-  Shirts: a cycle to wash shirts in a short time with the utmost care, using a delicate spin for easy ironing.
-  Synthetics: to wash your synthetic clothes (shirts, blouses, synthetic/cotton blends, etc.). It washes with a gentle action and has a shorter washing cycle compared to the Cottons programme. For curtains and tulle, use the Synthetic 40°C programme with prewash and anti-creasing functions selected. As their meshed texture causes excessive foaming, wash the veils/tulle by putting little amount of detergent into the main wash compartment. Do not put detergent in the prewash compartment.
-  Drum has maximum capacity of 7kg of dry laundry.
-  Delicate: Clothing such as underwear, hosiery and luxury fabrics should be dried on the delicate cycle to help extend the life of the clothing.
-  Program designed for clothes that have to be stored or used immediately.
-  Mixed fabrics: this cycle is designed for lightly soiled laundry in a mix of cottons and synthetics, or can be used just to refresh stored items.
-  Super fast 15 min: a programme designed to wash small amounts of laundry fast, ideal for washing lightly soiled garments.
-  To drain the water into the basket + centrifuge action
-  Gym: Gym, a cycle designed for washing lightly soiled garments, ie sports wear, this is a fast wash which is also kind to fabrics.
-  Wool: this programme for wool or delicate fabrics uses slower rotations of the drum to ensure the utmost care for clothing.