















WDF14C7SSA

EAN Code	8017709261610
Familie	Was-droogcombinatie
Commerciële breedte	60 cm
Commerciële diepte	Standaard capaciteit
Installatie	Vrijstaand
Type lading	Voorlader



Programs

Bediening	Elektronisch
Grafische weergave programma's	Tekst EN
Meertalig clipsysteem	
Languages clip	
Aantal programma's	15
Programma's	

 Cotton ECO	 Katoen	 Afpompen + centrifugeren
 Clean	 Delicaat	 Fijne was
 Gemixed	 Nachtprogramma	 Normal drying
 Overhemden/ Blouses	 Quick wash 15 min	 Spoelen + Centrifugeren
 Sport	 Synthetisch	 Wol

Wastemperatuur

Koud	30°C	40°C
60°C	75°C	90°C

Speciale programma's



Overhemden/ Blouses



Wol



Gemixed



Snel 15 min.



Sport

Speciaal Clean programma t.b.v. de reiniging van de leidingen Ja

Woolmark-code

Display

Weergave resttijd

Instelling Delay timer

Programmavoortgang indicatie

Centrifuge regeling

Temperatuurregeling

Type display



Toetsen/opties



Delay timer



Familie AS400



Voorwas



Extra spoelen



Niet centrifugeren



Stop tijdens weken



Anti-kreuk



Intensief



Koud wassen



Drogen

Programmavoortgang indicator

Op display

Indicator einde cyclus



Technische specificaties



Effectief verbruik

Type motor Standaard

Functionering met elektronische controle Ja

Programmaknop Ja

Centrifuge regeling op display/ LED 600/ 800/ 1000/ 1200/ 1400/ Nee

Temperatuurregeling op display/ LED Ja

Polypropyleen tank Ja

Korf Roestvrij staal

Capaciteit trommel 54 l

Variabele automatische lading Ja

Schuimbewaking Ja

Balanceringsysteem belading Automatisch

Makkelijk te bereiken filter Ja

Life Plus Resistance

Kinderbeveiliging Blokkeringsinstellingen

Anti-overloopsysteem Ja

AutoCleaning systeem Ja

Watertoevoer Enkel; koud water

Inbegrepen accessoires

Accessoire voor vloeibare reinigingsmiddelen meegeleverd	Ja	Meubeldeur kan rechts of links worden gemonteerd met verstelbare scharnieren
Diameter deur	30 cm	
Opening deur	180°	

Prestaties / energielabel









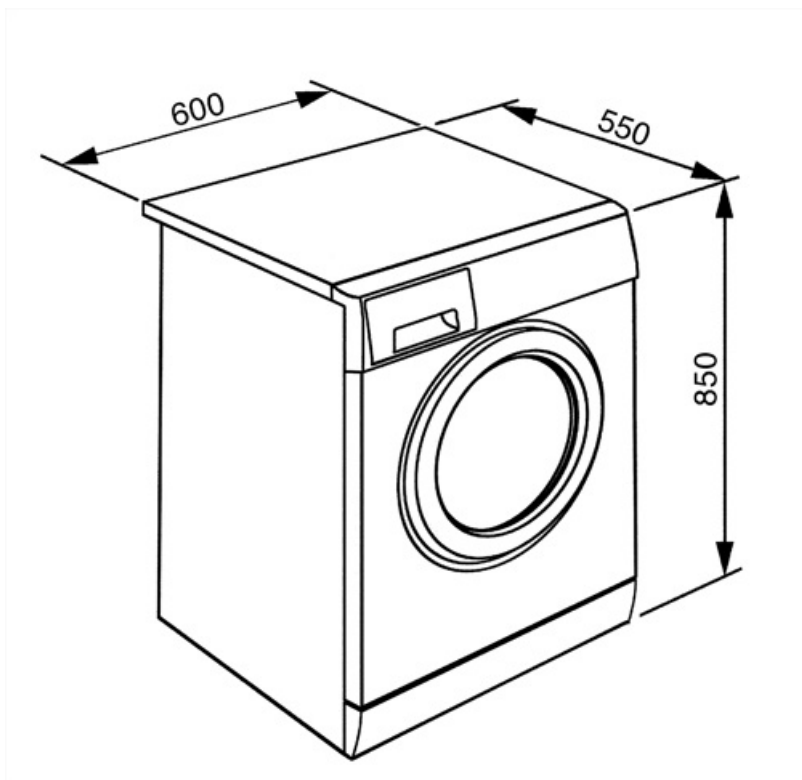













Laadcapaciteit wassen	7 kg	Energieverbruik (wassen - wassen + drogen)	5,6 kWh
Laadcapaciteit drogen	4 kg	Waterverbruik per cyclus wassen	49 l
Maximale centrifugesnelheid	1400 giri/min	Waterverbruik (wassen - wassen + drogen)	89 l
Energie-efficiëntieklasse	B	Duur normatief programma	420 min.
Efficiëntieklasse wassen	A	Totaal jaarlijks energieverbruik	260 kWh
Energieklasse	BA	Jaarlijks energieverbruik wassen en drogen	1120 kWh
Geluidsniveau wassen	59 dB(A) re 1 pW	Jaarlijks waterverbruik wassen	9800 l
Geluidsniveau centrifugeren	75 dB(A) re 1 pW	Jaarlijks waterverbruik wassen en drogen	17800 l
Geluidsniveau drogen	61 dB(A) re 1 pW	Resterende vochtigheidsgraad (%)	50 %
Energieverbruik - Katoen 60°C alleen wassen	1,3 kWh		















Performance / Energy Label - Reg. 2019

Supplier's name or trademark	SMEG
------------------------------	------



Symbols glossary

- | | |
|--|--|
|  <p>Easy Iron: dit is een optie die kan worden geselecteerd om ervoor te zorgen dat het wasgoed minder kreukt en het strijken gemakkelijker wordt</p> |  <p>Variable load: In all models of washing machines is present the system of variable load, according to which the machine automatically diversifies the wash cycle and the time of operation depending on the quantity and type of laundry introduced, allowing a significant saving of water and energy power, up to 30% compared to the versions with fixed load.</p> |
|  <p>Autocleaning-systeem: Autocleaning-systeem voorkomt de vorming van pluisjes en onzuiverheden in het condensatiesysteem en zorgt voor maximale betrouwbaarheid van de machine</p> |  <p>Automatic Load Balancing: provides an ideal distribution of laundry in the drum. In case if the imbalance is detected, the rotation speed starts being controlled in such way to evenly redistribute laundry in the drum, and thus reduce vibration.</p> |
|  <p>Acoustic signal: informs about the end of the drying cycle, in order to to get things out in time and avoid excessive creasing.</p> |  <p>Kinderslot: sommige modellen zijn voorzien van een apparaat om het programma / de cyclus te vergrendelen zodat het niet kan per ongeluk veranderd</p> |
|  <p>Cold wash</p> |  <p>Vertragingstimer: kan worden ingesteld om het programma op een geschikt tijdstip uit te voeren of om te profiteren van energieperiodes buiten de piekuren.</p> |
|  <p>B: Energieklasse van het product, gemeten van A+++ tot D / G, afhankelijk van de productfamilie.</p> |  <p>LED-display: toont de geselecteerde programma's, functies en opties en de tijd tot het einde van de cyclus.</p> |
|  <p>30 cm: Large loading hatch of 30-32-33 cm in diameter, makes laundry loading and unloading easier and faster with maximum ease of use.</p> |  <p>Behoedzaam drogen: programma ontworpen om de was klaar te maken voor gemakkelijk strijken.</p> |
|  <p>This shows the amount of laundry that can be inserted into the tumble dryer in KG.</p> |  <p>This option advises when the periodic cleaning of the filters is needed, in order to avoid forgetfulness and thus guarantee the perfect functioning of the dryer over time. The convenient position of the filters makes maintenance fast and extremely simple.</p> |
|  <p>FlexiTime: The FlexiTime option allows the user to reduce the time of the cycle selected, providing extra flexibility and control.</p> |  <p>Intensive: this option intensifies the selected program. Cycle duration and water consumption are reduced by taking into account the type of laundry, while still guaranteeing excellent washing results, even in the case of stains that are difficult to eliminate.</p> |
|  <p>No spin option: this option allows to exclude the last spin phase, draining the water from the tank</p> |  <p>Prewash: program designed for heavily soiled garments.</p> |
|  <p>Cleaning programme: A cleaning programme has been created to maintain the performance of washer/dryers. The display shows automatically when cleaning is required.</p> |  <p>Cotton: For soiled fabrics in cotton</p> |

-  Use to wash your normally soiled, durable cotton and linen laundry. Although it washes longer than all other programmes, it provides high energy and water savings. Actual water temperature may be different from the stated wash temperature. When you load the machine with less laundry (e.g. ½ capacity or less), programme time may automatically get shorter. In this case, energy and water consumption will decrease more, providing a more economic wash. This programme is available in the models with the remaining time indicator.
-  To drain the water in the machine.
-  Extra Rinse: Extra Rinse: adds an extra rinse cycle to that already provided in the program chosen, to remove any residual detergent. This function is particularly suitable for those with allergies or skin problems.
-  Night: an ideal programme for those who want to take advantage of off-peak energy periods, this cycle is particularly quiet due to slower rotations of the drum.
-  Terminato il lavaggio il ciclo si blocca con l'acqua in vasca
-  Shirts: a cycle to wash shirts in a short time with the utmost care, using a delicate spin for easy ironing.
-  Synthetics: to wash your synthetic clothes (shirts, blouses, synthetic/cotton blends, etc.). It washes with a gentle action and has a shorter washing cycle compared to the Cottons programme. For curtains and tulle, use the Synthetic 40°C programme with prewash and anti-creasing functions selected. As their meshed texture causes excessive foaming, wash the veils/tulle by putting little amount of detergent into the main wash compartment. Do not put detergent in the prewash compartment.
-  Drum has maximum capacity of 7kg of dry laundry.
-  Delicate: Clothing such as underwear, hosiery and luxury fabrics should be dried on the delicate cycle to help extend the life of the clothing.
-  Program designed for clothes that have to be stored or used immediately.
-  Mixed fabrics: this cycle is designed for lightly soiled laundry in a mix of cottons and synthetics, or can be used just to refresh stored items.
-  Super fast 15 min: a programme designed to wash small amounts of laundry fast, ideal for washing lightly soiled garments.
-  To drain the water into the basket + centrifuge action
-  Gym: Gym, a cycle designed for washing lightly soiled garments, ie sports wear, this is a fast wash which is also kind to fabrics.
-  Wool: this programme for wool or delicate fabrics uses slower rotations of the drum to ensure the utmost care for clothing.