















# WDFS14C7

EAN Code	8017709232306
Produktfamilie	Vollwaschtrockner
Komm. Breite	60 cm
Komm. Tiefe	Standard
Beladungstyp	Frontlader



## Programme

Bedienungsart	Elektronisch
Programmgrafik	Schriftzug (EN)
Schriftzüge/Sprachen-Clip	
Anzahl der Waschprogramme	15
Programme	

 Baumwolle	 Baumwolle ECO	 Abpumpen/Schleudern
 Hemden/Business	 Kurz 15 min.	 Mix
 Nacht	 Pflegeleicht	 Sport
 Spülen/Schleudern	 Synthetik	 Trocknen Normal
 Trocknen pflegeleicht	 Waschen	 Wolle

### Variable Temperaturregelung

Kaltwäsche	30°C	40°C
60°C	75°C	90°C

### Sonderprogramme

 Wolle	 Mix	 Schnell 30°C - 15 min.
--	---	--

Auto-Cleaning-System (Autom. Kondensatorreinigung)	Ja
--	----

## Wollprogramm Code "The Woolmark Company" Displayanzeige

Restzeitanzeige

Zeitvorwahl

Füllmengenvorgabe

Programmstatus

Display



Sonderfunktionen



Zeitvorwahl



Vorwäsche



Extraspülen



Schleuderausschluss



Bügelleicht



Schnell



Intensiv



Kaltwäsche



Trocknen

Anzeige Programmstatus

Ja

Anzeige Programmende

Ja

## Technische Eigenschaften



Effektiver Verbrauch

Motortyp

Standard

Elektronische

Ja

Unwuchtkontrolle

Programmwahl über  
Bedienknebel

Ja

Temperaturwahl über  
Bedienknebel

Variable

Schleuderausschluss/ 600/  
800/ 1000/ 1200/ 1400

Schleuderdrehzahl über  
Display/Led

Temperaturregelung  
über Display

Ja

Einspülkammer:  
Kunststoff (PP)

Ja

Trommelmaterial

Edelstahl

Trommelvolumen

54 l

Einsatz für

Ja

Flüssigwaschmittel

Beladungsöffnung Ø

30 cm

Türöffnungswinkel

180°

Mengenautomatik

Ja

Schaumerkennung

Ja

Unwuchtkontrolle

Ja

Flusensieb/Fremdkörperfalle  
herausnehmbar

Ja

Tastensperre/Kindersicherung

Ja

Überlaufschutz

Ja

Auto Cleaning-System  
(Autom.  
Kondensatorreinigung)

Ja

Stop-Aqua

Ja

Wasserschutzsystem

Wasseranschluss

kalt

Serienzubehör

Wechselseitiger Türanschlag  
der Möbeltür

## Technische Daten / Energielabel



Nennkapazität  
Baumwollwäsche

7 kg

Energieverbrauch

5,6 kWh

(Waschen und Trocknen)







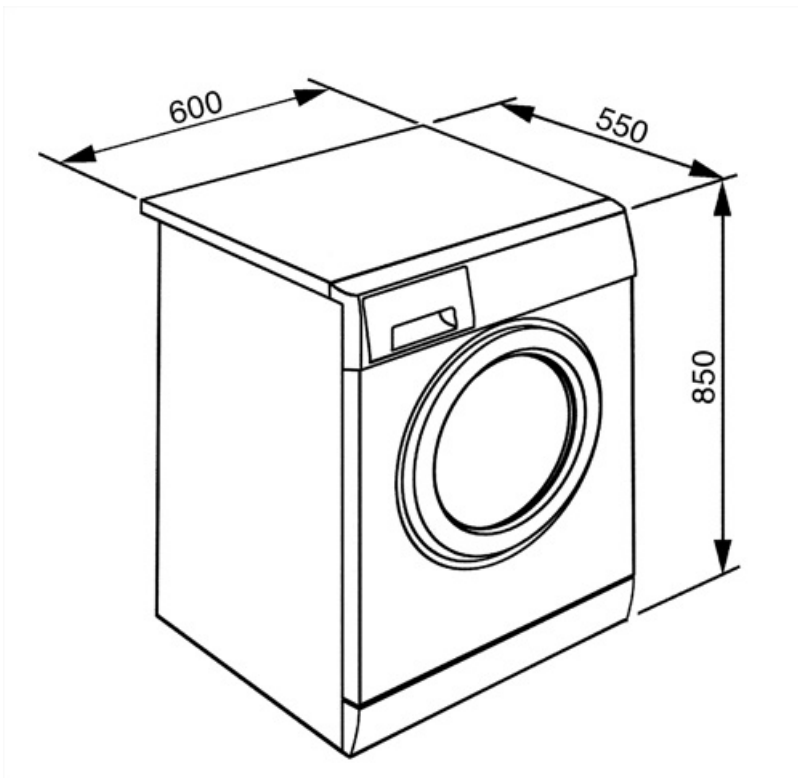







Nennkapazität im Standard-Trocknungsprogramm für Baumwolle	4 kg	Wasserverbrauch (Waschgang) pro Zyklus	49 l
Max. Schleuderdrehzahl	1400 U/min	Wasserverbrauch (Waschen und Trocknen) im Standardprogramm Baumwolle	89 l
Energieeffizienzklasse auf einer Skala von A+++ (höchste Effizienz) bis D (geringste Effizienz)	B	Dauer des Standardprogramms	420 min.
Waschwirkungsklasse auf einer Skala von A (höchste Effizienz) bis G (niedrigste Effizienz)	A	Energieverbrauch (Waschgang)	260 kWh
Energieeffizienzklasse	BA	Energieverbrauch (Waschen + Trocknen)	1120 kWh
Luftschallemissionen (Waschen)	59 dB(A) re 1 pW	Wasserverbrauch (Waschgang)	9800 l
Luftschallemissionen (Schleudern)	75 dB(A) re 1 pW	Wasserverbrauch (Waschen und Trocknen)	17800 l
Luftschallemissionen (Trocknen)	61 dB(A) re 1 pW	Restfeuchte	55 %
Energieverbrauch des Standardprogramms "Baumwolle" 60°C bei vollständiger Befüllung	1,3 kWh		





















## Technische Daten / Energielabel - Reg. 2019 - bindend ab 1.3.2021

Name oder Handelsmarke des Lieferanten  
SMEG



## Symbols glossary

- |   |   |
|---|---|
| <p> <b>Total acquastop:</b> Most models of Smeg dishwashers are equipped with Acquastop Totale, which allows to avoid flooding as a result of water leakage. The system consists of a float sensor, disposed under the inner chamber of a dishwasher, which blocks water supply inside the appliance in case of water leakage into the lower tray. An additional electromagnetic valve on the water inlet hose also automatically blocks water supply if detecting water leakage in the hose. For Laundry: Total acquastop, the product is built with 3 levels of anti-flood devices to ensure protection against water leakage. For Laundry: Total acquastop, the product is built with 3 levels of anti-flood devices to ensure protection against water leakage.</p> | <p> <b>Easy Iron:</b> this is an option which can be selected to ensure the finished laundry is left with less creases to make ironing easier.</p>   |
| <p> <b>Variable load:</b> In all models of washing machines is present the system of variable load, according to which the machine automatically diversifies the wash cycle and the time of operation depending on the quantity and type of laundry introduced, allowing a significant saving of water and energy power, up to 30% compared to the versions with fixed load.</p>  | <p> <b>Auto-Cleaning-System:</b> Das Selbstreinigungssystem verhindert die Bildung von Flusen und Verunreinigungen im Kondensationssystem und sorgt für maximale Zuverlässigkeit der Maschine</p>  |
| <p> <b>Automatic Load Balancing:</b> provides an ideal distribution of laundry in the drum. In case if the imbalance is detected, the rotation speed starts being controlled in such way to evenly redistribute laundry in the drum, and thus reduce vibration.</p>   | <p> <b>Kindersicherung:</b> Eine Tastensperre, die einen ungewollten Zugriff auf die Funktionen verhindert.</p>  |
| <p> <b>Cold wash</b></p>  | <p> <b>Delay timer:</b> can be set to run the programme at a convenient time or to take advantage of off-peak energy periods.</p>  |
| <p> <b>Energieeffizienzklasse B</b></p>   | <p> <b>LED-Display:</b> zur optischen Anzeige der gewählten Programme, Funktionen und Optionen sowie die Restlaufzeit bis Programmende.</p>  |
| <p> <b>30 cm:</b> Large loading hatch of 30-32-33 cm in diameter, makes laundry loading and unloading easier and faster with maximum ease of use.</p>   | <p> <b>Gentle drying:</b> program designed to get laundry ready for easy ironing.</p>  |
| <p> <b>This shows the amount of laundry that can be inserted into the tumble dryer in KG.</b></p>   | <p> <b>This option advises when the periodic cleaning of the filters is needed, in order to avoid forgetfulness and thus guarantee the perfect functioning of the dryer over time. The convenient position of the filters makes maintenance fast and extremely simple.</b></p> |

- |  |   |
|--|---|
|  <p><b>Intensive:</b> this option intensifies the selected program. Cycle duration and water consumption are reduced by taking into account the type of laundry, while still guaranteeing excellent washing results, even in the case of stains that are difficult to eliminate.</p> |  <p><b>No spin option:</b> this option allows to exclude the last spin phase, draining the water from the tank</p>   |
|  <p><b>Prewash:</b> program designed for heavily soiled garments.</p>  |  <p><b>Cleaning programme:</b> A cleaning programme has been created to maintain the performance of washer/dryers. The display shows automatically when cleaning is required.</p>  |
|  <p><b>Cotton:</b> For soiled fabrics in cotton</p>  |  <p>Use to wash your normally soiled, durable cotton and linen laundry. Although it washes longer than all other programmes, it provides high energy and water savings. Actual water temperature may be different from the stated wash temperature. When you load the machine with less laundry (e.g. ½ capacity or less), programme time may automatically get shorter. In this case, energy and water consumption will decrease more, providing a more economic wash. This programme is available in the models with the remaining time indicator.</p> |
|  <p><b>Delicate:</b> Clothing such as underwear, hosiery and luxury fabrics should be dried on the delicate cycle to help extend the life of the clothing.</p>   |  <p>To drain the water in the machine.</p>   |
|  <p>Program designed for clothes that have to be stored or used immediately.</p>   |  <p>Verlängerte Nachspülung</p>  |
|  <p><b>Mixed fabrics:</b> this cycle is designed for lightly soiled laundry in a mix of cottons and synthetics, or can be used just to refresh stored items.</p>   |  <p>PRG NACHT</p>  |
|  <p><b>Super fast 15 min:</b> a programme designed to wash small amounts of laundry fast, ideal for washing lightly soiled garments.</p>   |  <p><b>Super fast:</b> a programme designed to wash small amounts of laundry fast, ideal for washing lightly soiled garments.</p>  |
|  <p>To drain the water into the basket + centrifuge action</p>   |  <p><b>Shirts:</b> a cycle to wash shirts in a short time with the utmost care, using a delicate spin for easy ironing.</p>  |
|  <p><b>Gym:</b> Gym, a cycle designed for washing lightly soiled garments, ie sports wear, this is a fast wash which is also kind to fabrics.</p>  |  <p><b>Synthetics:</b> to wash your synthetic clothes (shirts, blouses, synthetic/cotton blends, etc.). It washes with a gentle action and has a shorter washing cycle compared to the Cottons programme. For curtains and tulle, use the Synthetic 40°C programme with prewash and anti-creasing functions selected. As their meshed texture causes excessive foaming, wash the veils/tulle by putting little amount of detergent into the main wash compartment. Do not put detergent in the prewash compartment.</p>                                |
|  <p><b>Wool:</b> this programme for wool or delicate fabrics uses slower rotations of the drum to ensure the utmost care for clothing.</p>   |  <p>Option that allow to reduce times of the selected program.</p>   |



Drum has maximum capacity of 7kg of dry laundry.