

WDI147D-1

EAN Code	8017709199326
Product Family	Washer dryer
Commercial width	60 cm
Installation	Fully integrated
Load type	Frontal



Programmes

Controls

Programmes graphics

No. of programmes

Programmes

Electronic

Written in EN

15



Cotton 40°



Cotton 60°



Cotton 90°



Cotton Cold



Clean



Delicate drying



Drain + Spin



Mix 30°



Normal drying



Quick Wash 30°



Rinse + Spin



Synthetics 30°



Synthetics 40°



Wool 30°



Wool Cold

Washing Temperature

Cool

30°C

40°C

60°C

90°C

Special programmes



Handwash



Mix



Quick 15 min



Curtains

Special Clean programme, to remove residual fluff Yes

Display



Residual time indicator delay start Recommended load indicator

programme status indication spin regulation

Display type



Buttons/Options

 Prewash  Additional rinse  Anti-wrinkle (easy ironing)

 Quick  Intensive

Programme progress indicator (light) On display

End of cycle indicator (light) On display

Technical Features

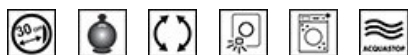

Type of motor	Standard	Door opening	180°
Electronic control functioning	Yes	Automatic variable load	Yes
Programme selection knob	Yes	Antifoam system	Yes
Programme/temperature selection knob	Yes	Load balancing system	Automatic
Spin speed selection on display/LED	No spin/ 600/ 800/ 1000/ 1200/ 1400	Easy to access filter	Yes
Polypropilene tank	Yes	Anti-flood system	Yes
Basket	Stainless steel	Autocleaning system	Yes
Drum capacity	52 l	Aquastop system	Total
Liquid detergent accessory as standard	Yes	Water supply	Single, cold
Door diameter	30 cm	Furniture door can be fitted on right or left side with adjustable hinges	Yes

Performance / Energy Label



Washing loading capacity	7 kg	Energy consumption (washing + drying)	5,6 kWh
Drying loading capacity	4 kg	Water consumption (washing) per cycle	49 l
Max spin speed	1400 rpm	Water consumption (washing+drying) per cycle	89 l
Energy efficiency class	B	Duration of the normative programme	420 min.
Washing efficiency class	A	Energy annual consumption (washing)	260 kWh
Energy rating	BA		
Noise level washing	56 dB(A) re 1 pW		
Noise level spinning	72 dB(A) re 1 pW		
Noise level drying	58 dB(A) re 1 pW		

Energy consumption - 1,3 KWh
Cotton 60° - Wash only







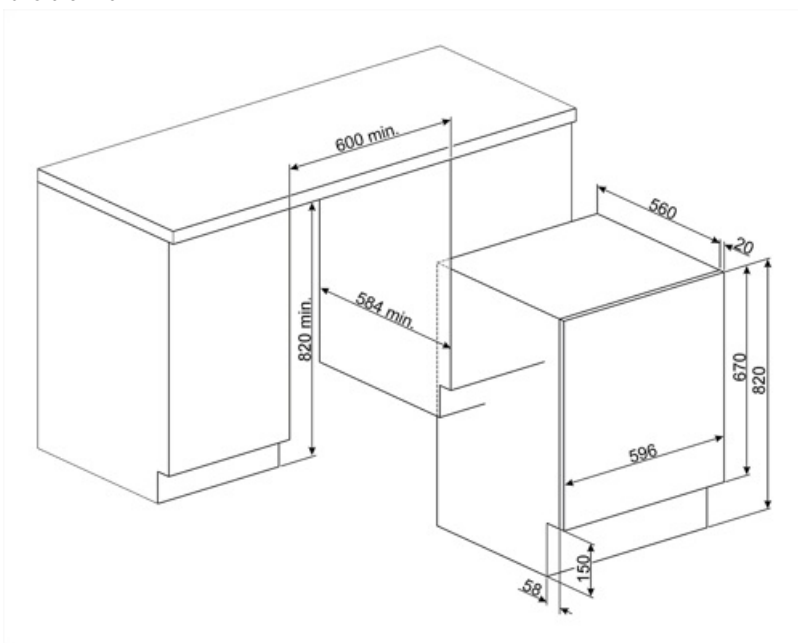











Energy annual consumption (washing+drying) 1120 KWh
Water annual consumption (washing) 9800 l
Water annual consumption (washing+drying) 17800 l
Residual humidity percentage (%) 50 %

















Performance / Energy Label

Supplier's name or trademark SMEG



Symbols glossary

 <p>Total acquastop: Most models of Smeg dishwashers are equipped with Acquastop Totale, which allows to avoid flooding as a result of water leakage. The system consists of a float sensor, disposed under the inner chamber of a dishwasher, which blocks water supply inside the appliance in case of water leakage into the lower tray. An additional electromagnetic valve on the water inlet hose also automatically blocks water supply if detecting water leakage in the hose. For Laundry: Total acquastop, the product is built with 3 levels of anti-flood devices to ensure protection against water leakage. For Laundry: Total acquastop, the product is built with 3 levels of anti-flood devices to ensure protection against water leakage.</p>	 <p>Easy Iron: this is an option which can be selected to ensure the finished laundry is left with less creases to make ironing easier.</p>
 <p>Variable load: In all models of washing machines is present the system of variable load, according to which the machine automatically diversifies the wash cycle and the time of operation depending on the quantity and type of laundry introduced, allowing a significant saving of water and energy power, up to 30% compared to the versions with fixed load.</p>	 <p>Autocleaning system: Autocleaning system avoids the formation of lint and impurities inside the condensation system ensuring maximum reliability of the machine</p>
 <p>Automatic Load Balancing: provides an ideal distribution of laundry in the drum. In case if the imbalance is detected, the rotation speed starts being controlled in such way to evenly redistribute laundry in the drum, and thus reduce vibration.</p>	 <p>B: Product energy rating, measured from A+++ to D / G depending on the product family.</p>
 <p>LED display: to show programmes, functions and options selected and the time to the end of the cycle.</p>	 <p>30 cm: Large loading hatch of 30-32-33 cm in diameter, makes laundry loading and unloading easier and faster with maximum ease of use.</p>
 <p>Gentle drying: program designed to get laundry ready for easy ironing.</p>	 <p>This shows the amount of laundry that can be inserted into the tumble dryer in KG.</p>
 <p>This option advises when the periodic cleaning of the filters is needed, in order to avoid forgetfulness and thus guarantee the perfect functioning of the dryer over time. The convenient position of the filters makes maintenance fast and extremely simple.</p>	 <p>Intensive: this option intensifies the selected program. Cycle duration and water consumption are reduced by taking into account the type of laundry, while still guaranteeing excellent washing results, even in the case of stains that are difficult to eliminate.</p>
 <p>Prewash: program designed for heavily soiled garments.</p>	 <p>Cleaning programme: A cleaning programme has been created to maintain the performance of washer/dryers. The display shows automatically when cleaning is required.</p>
 <p>Cotton 40°: For soiled fabrics in cotton</p>	 <p>Cotton 60°: For soiled fabrics in cotton</p>
 <p>Cotton 90°: For soiled fabrics in cotton</p>	 <p>Cotton Cold: For soiled fabrics in cotton</p>

-
- | | | | |
|--|---|---|---|
|  | Curtains: Program for washing the curtains. |  | To drain the water in the machine. |
|  | Program designed for clothes that have to be stored or used immediately. |  | Extra Rinse: Extra Rinse: adds an extra rinse cycle to that already provided in the program chosen, to remove any residual detergent. This function is particularly suitable for those with allergies or skin problems. |
|  | Hand wash: this specific programme for delicate fabrics uses slower rotations of the drum to ensure the utmost care for clothing. |  | Mix 30°: washing program that allows to wash your cotton and synthetic clothes together without sorting them. |
|  | Mixed fabrics: this cycle is designed for lightly soiled laundry in a mix of cottons and synthetics, or can be used just to refresh stored items. |  | Super fast 15 min: a programme designed to wash small amounts of laundry fast, ideal for washing lightly soiled garments. |
|  | Super fast 30°: a programme designed to wash small amounts of laundry fast, ideal for washing lightly soiled garments. |  | To drain the water into the basket + centrifuge action |
|  | Synthetic 30 °: washing program at 30 ° for Synthetics items |  | Synthetic 40 °: washing program at 30 ° for Synthetics items |
|  | Wool 30°: this programme for wool or delicate fabrics uses slower rotations of the drum to ensure the utmost care for clothing. |  | Wool Cold: this programme for wool or delicate fabrics uses slower rotations of the drum to ensure the utmost care for clothing. |
|  | Option that allow to reduce times of the selected program. |  | Drum has maximum capacity of 7kg of dry laundry. |