

WDI147D-2

EAN Code	8017709302740
Product Family	Washer dryer
Commercial width	60 cm
Commercial depth	Standard capacity
Installation	Built-in
Load type	Frontal



Programs

Controls	Electronic
Programmes graphics	Written in EN
No. of programmes	15
Programmes	

Eco 40-60

Intensive drying

 Cotton 20°

 Cotton 40°

 Cotton 60°

 Cotton 90°

 Clean

 Delicate drying

 Drain + Spin

 Mix 30°

 Quick Wash 15' 30°

 Rinse + Spin

 Synthetics 30°

 Synthetics 40°

 Wool Cold

Washing Temperature

Cool

20°C

30°C

40°C

60°C

90°C

Special programmes

 Handwash

 Mix

 Quick 15 min

 Curtains

Special Clean programme, to remove residual fluff Yes

Display

Residual time indicator	delay start	Recommended load indicator
programme status indication	spin regulation	

Display type



Buttons/Options



Prewash



Additional rinse



Anti-wrinkle (easy ironing)



Quick



Intensive

Programme progress indicator (light)	On display
End of cycle indicator (light)	On display

Technical Features



Type of motor	Standard	Door opening	180°
Electronic control functioning	Yes	Automatic variable load	Yes
Programme selection knob	Yes	Antifoam system	Yes
Programme/temperature selection knob	Yes	Load balancing system	Automatic
Spin speed selection on display/LED	No spin/ 600/ 800/ 1000/ 1200/ 1400	Easy to access filter	Yes
Polypropilene tank	Yes	Anti-flood system	Yes
Basket	Stainless steel	Autocleaning system	Yes
Drum capacity	52 l	Aquastop system	Total
Liquid detergent accessory as standard	Yes	Water supply	Single, cold
Door diameter	30 cm	Furniture door can be fitted on right or left side with adjustable hinges	Yes

Performance / Energy Label



Washing loading capacity	7 kg	Energy consumption (washing + drying)	5,6 kWh
Drying loading capacity	4 kg	Water consumption (washing) per cycle	49 l
Max spin speed	1400 giri/min	Water consumption (washing+drying) per cycle	89 l
Energy efficiency class	B	Duration of the normative programme	420 min
Washing efficiency class	A	Energy annual consumption (washing)	260 kWh
Energy rating	BA		
Noise level washing	56 dB(A) re 1 pW		
Noise level spinning	72 dB(A) re 1 pW		
Noise level drying	58 dB(A) re 1 pW		

Energy consumption - 1,3 kWh
Cotton 60° - Wash only

Energy annual consumption (washing+drying) 1120 kWh
Water annual consumption (washing) 9800 l
Water annual consumption (washing+drying) 17800 l
Residual humidity percentage (%) 50 %

Performance / Energy Label - Reg. 2019







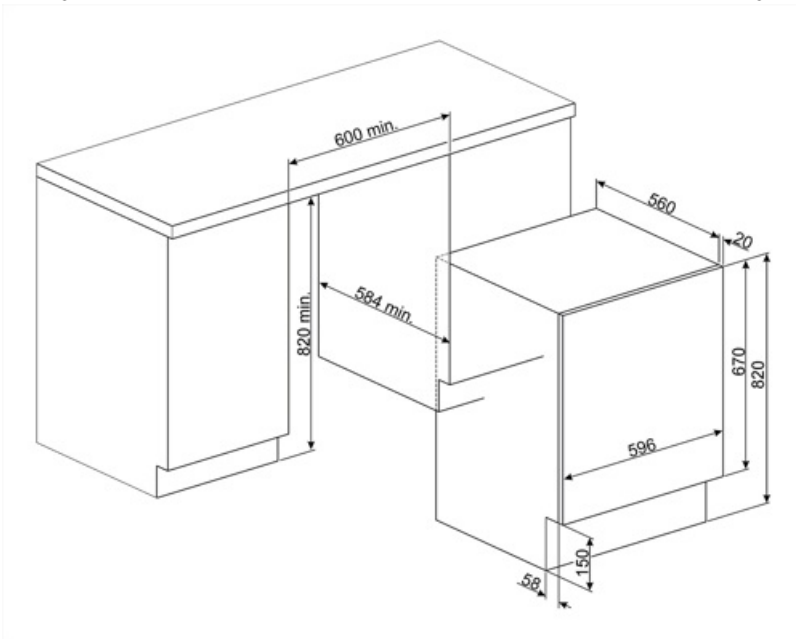



















Supplier's name or trademark SMEG
Rated capacity washing cycle 7 kg
Rated capacity complete cycle 4 kg
Energy efficiency class (washing cycle) E
Energy efficiency class (complete cycle) E
Weighted energy consumption lavaggio 77 kWh
weighted energy consumption (ciclo complete) 266 kWh

Water consumption (washing cycle) 44 litre
Water Consumption (complete cycle) 68 litre
Spin-drying efficiency class B
Airbone acoustical noise class A
Airbone acoustical noise 72 dB(A) re 1 pW
Eco 40-60 programme duration (Rated washing capacity) 2:50 h:min
Wash and dry cycle duration (Rated capacity) 5:30 h:min



Symbols glossary

 <p>Total acquastop: Most models of Smeg dishwashers are equipped with Acquastop Totale, which allows to avoid flooding as a result of water leakage. The system consists of a float sensor, disposed under the inner chamber of a dishwasher, which blocks water supply inside the appliance in case of water leakage into the lower tray. An additional electromagnetic valve on the water inlet hose also automatically blocks water supply if detecting water leakage in the hose. For Laundry: Total acquastop, the product is built with 3 levels of anti-flood devices to ensure protection against water leakage.</p>	 <p>Easy Iron: this is an option which can be selected to ensure the finished laundry is left with less creases to make ironing easier.</p>
 <p>Variable load: In all models of washing machines is present the system of variable load, according to which the machine automatically diversifies the wash cycle and the time of operation depending on the quantity and type of laundry introduced, allowing a significant saving of water and energy power, up to 30% compared to the versions with fixed load.</p>	 <p>Autocleaning system: Autocleaning system avoids the formation of lint and impurities inside the condensation system ensuring maximum reliability of the machine.</p>
 <p>Automatic Load Balancing: provides an ideal distribution of laundry in the drum. In case if the imbalance is detected, the rotation speed starts being controlled in such way to evenly redistribute laundry in the drum, and thus reduce vibration.</p>	 <p>B: Product energy rating, measured from A+++ to D / G depending on the product family.</p>
 <p>LED display: to show programmes, functions and options selected and the time to the end of the cycle.</p>	 <p>30 cm: Large loading hatch of 30-32-33 cm in diameter, makes laundry loading and unloading easier and faster with maximum ease of use.</p>
 <p>Gentle drying: program designed to get laundry ready for easy ironing.</p>	 <p>This shows the amount of laundry that can be inserted into the tumble dryer in KG.</p>
 <p>This option advises when the periodic cleaning of the filters is needed, in order to avoid forgetfulness and thus guarantee the perfect functioning of the dryer over time. The convenient position of the filters makes maintenance fast and extremely simple.</p>	 <p>Intensive option: this function extends the duration of the wash cycle and increases the intensity of the wash, ensuring a deeper cleaning for heavily soiled garments.</p>
 <p>Prewash: program designed for heavily soiled garments.</p>	 <p>Cleaning programme: A cleaning programme has been created to maintain the performance of washer/dryers. The display shows automatically when cleaning is required.</p>
 <p>For lightly soiled fabrics in cotton and linen</p>	 <p>Cotton 40°: For soiled fabrics in cotton</p>
 <p>Cotton 60°: For soiled fabrics in cotton</p>	 <p>Cotton 60°: For soiled fabrics in cotton</p>
 <p>Curtains: Program for washing the curtains.</p>	 <p>To drain the water in the machine.</p>

- | | | | |
|---|---|---|---|
|  | Extra Rinse: Extra Rinse: adds an extra rinse cycle to that already provided in the program chosen, to remove any residual detergent. This function is particularly suitable for those with allergies or skin problems. |  | Hand wash: this specific programme for delicate fabrics uses slower rotations of the drum to ensure the utmost care for clothing. |
|  | Mix 30°: washing program that allows to wash your cotton and synthetic clothes together without sorting them. |  | Mixed fabrics: this cycle is designed for lightly soiled laundry in a mix of cottons and synthetics, or can be used just to refresh stored items. |
|  | Rapid 15-30 ° : Rapid washing program at 30 °, let to clean slightly dirty items in a very short time. |  | Quick 15 min.: ideal for small loads of lightly soiled garments, it guarantees a fast wash in a very short time. |
|  | Rinse and Spin: this programme is suitable for rinsing and spinning garments. |  | Synthetic 30 °: washing program at 30 ° for Synthetics items |
|  | Synthetic 40 °: washing program at 30 ° for Synthetics items |  | Wool Cold: this programme for wool or delicate fabrics uses slower rotations of the drum to ensure the utmost care for clothing. |
|  | Option that allow to reduce times of the selected program. |  | Drum has maximum capacity of 7kg of dry laundry. |
|  | Energy efficiency class E | | |