

WM3T04XSA

EAN Code	8017709340971
Product Family	Washing Machine
Commercial width	60 cm
Commercial depth	Standard
Installation	Free-standing
Load type	Frontal



Aesthetics

Colour	Dark Inox	Programme/temperature knob colour	Chrome
Front panel colour	Black	Door colour	Black with chrome ring
Led/display colour	White	Door window	Giant door
Front panel type	T3	Handle colour	Chrome
Function buttons colour	Cromato	Drawer Color	Black
On/Off buttons colour	Cromato	Cabinet colour	Silver
No. of control knobs	1	Top colour	Black

Programs

Controls	Electronic
Programmes graphics	Written in EN
No. of programmes	15

Programmes

Quick wash 12 min



Colors

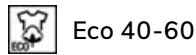
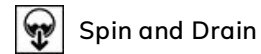
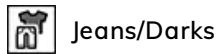

Outdoor

Duvet

Fast 60'

Washing Temperature

Cool

20°C

30°C

40°C

60°C

90°C

Special programmes

Outdoor

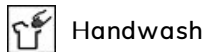
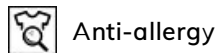

Display

Residual time indicator

delay start

spin regulation

temperature regulation

Display type



Buttons/Options

Options

Save+ / Express

Autodose

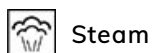
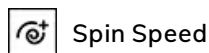

End of cycle indicator (light)

On display

Technical Features



Effective consumption 20% less energy consumption than energy rating A+++

Door diameter 51 cm
Door opening 160°
Automatic variable load Yes

Type of motor	Brushless/Inverter	Antifoam system	Yes
Electronic control functioning	Yes	Load balancing system	Automatic
Programme selection knob	Yes	Easy to access filter	Yes
Spin speed selection on display/LED	No spin/ 400/ 800/ 1000/ 1200/ 1400	Child lock (functions block)	Control block
Display/led for temperature regulation	Yes	Anti-flood system	Yes
Polypropilene tank	Yes		
Basket	Stainless steel		
Drum capacity	62 l		

Electrical Connection

Nominal power	2200 W	Frequency (Hz)	50 Hz
Current	10 A	Power supply cable length	160 cm
Voltage (V)	220-240 V	Plug	(M) Sud Africa

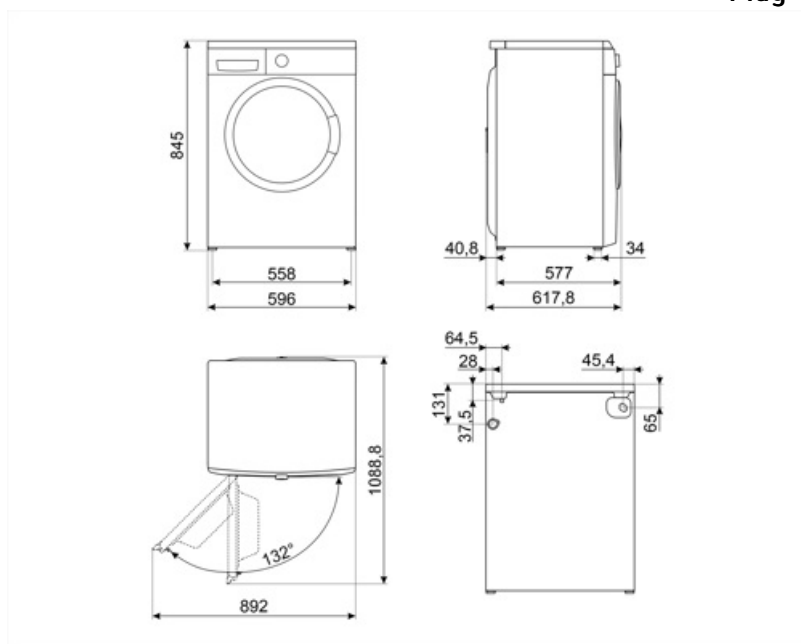





















Compatible Accessories

KITPLV2

Kit extension for dishwasher and washing machine: lenght mt. 2



Symbols glossary

 <p>Variable load: In all models of washing machines is present the system of variable load, according to which the machine automatically diversifies the wash cycle and the time of operation depending on the quantity and type of laundry introduced, allowing a significant saving of water and energy power, up to 30% compared to the versions with fixed load.</p>	 <p>Automatic Load Balancing: provides an ideal distribution of laundry in the drum. In case if the imbalance is detected, the rotation speed starts being controlled in such way to evenly redistribute laundry in the drum, and thus reduce vibration.</p>
 <p>Child lock: some models are fitted with a device to lock the programme/cycle so it cannot be accidentally changed.</p>	 <p>A+++: Appliances with this symbol can reduce energy consumption by a further 30% from the standard A energy rating.</p>
 <p>Delay timer: can be set to run the programme at a convenient time or to take advantage of off-peak energy periods.</p>	 <p>LED display: to show programmes, functions and options selected and the time to the end of the cycle.</p>
 <p>This option advises when the periodic cleaning of the filters is needed, in order to avoid forgetfulness and thus guarantee the perfect functioning of the dryer over time. The convenient position of the filters makes maintenance fast and extremely simple.</p>	 <p>Smeg's evolution towards more intelligent and eco-friendly models has led to the choice of Inverter technology, which significantly reduces consumption.</p>
 <p>Antiallergic: Antiallergic program with particular attention to the total removal of residual detergent.</p>	 <p>For lightly soiled fabrics in cotton and linen</p>
 <p>Cotton: For soiled fabrics in cotton</p>	 <p>Use to wash your normally soiled, durable cotton and linen laundry. Although it washes longer than all other programmes, it provides high energy and water savings. Actual water temperature may be different from the stated wash temperature. When you load the machine with less laundry (e.g. ½ capacity or less), programme time may automatically get shorter. In this case, energy and water consumption will decrease more, providing a more economic wash. This programme is available in the models with the remaining time indicator.</p>
 <p>Prewash cotton</p>	 <p>To drain the water in the machine.</p>
 <p>Hand wash: this specific programme for delicate fabrics uses slower rotations of the drum to ensure the utmost care for clothing.</p>	 <p>Super fast 12 min: a programme designed to wash small amounts of laundry fast, ideal for washing lightly soiled garments.</p>
 <p>Extra rinse: The Extra rinse option: can be added to the selected programme when more thorough cleansing of special fabrics is needed.</p>	 <p>Spin speed control: On the control panel there is a spin speed control knob. In some models, the maximum spin speed is 1400 rpm / min. You can also to exclude spin.</p>
 <p>Wool: this programme for wool or delicate fabrics uses slower rotations of the drum to ensure the utmost care for clothing.</p>	 <p>Steam Option: the steam is perfect for smoothing out creases, refreshing fabrics, neutralizing odors and releasing dirt, destroying allergens more quickly than by washing the item in water.</p>



Jeans / Dark garments: Special cycle designed to meet the washing needs of jeans or dark garments. The program allows you to wash the garments respecting colors and minimizing creases thanks to minimal mechanical action and low temperatures.



Drum has maximum capacity of 10kg of dry laundry.



Temperature Adjustment: allows you to tailor the wash cycle to your needs by selecting the most suitable temperature to protect fabrics, remove dirt, and achieve optimal results with every wash.

Benefit (TT)

Standard dimensions to fit any home environment, with optimal capacity and advanced features

15 programmes

Up to 15 programmes to meet every daily need

LED Display

With soft touch control and LED lights for intuitive and fast setting and selection of each option

Inverter

Brushless, it offers greater energy efficiency, lower consumption and longer life, reducing wear and noise. It optimises consumption and ensures high performance while maintaining high washing efficiency.

Giant door

The size of the door offers greater convenience and versatility, facilitating the loading and unloading of laundry thanks to its wide opening, and gives a more premium and elegant look, enriching the overall design of the appliance