

WM3T84SSA

EAN Code	8017709340964
Product Family	Washing Machine
Commercial width	60 cm
Commercial depth	Standard
Installation	Free-standing
Load type	Frontal



Aesthetics

Colour	Silver	Door colour	Black with silver profile
Front panel colour	Black	Door window	Giant door
Led/display colour	White	Handle colour	Silver
Front panel type	T3	Drawer Color	Black
Function buttons colour	Black	Cabinet colour	Silver
On/Off buttons colour	Silver	Top colour	Black
No. of control knobs	1		

Programs

Controls	Electronic
Programmes graphics	Written in EN
No. of programmes	15
Programmes	

 Rapid 15'	 Allergy Safe	Colors
 Jeans/Darks	 Hand Wash	 Spin and Drain
 Rinse	 Cotton	 Cotton 20°
 Cotton Prewash	 Eco 40-60	 Wool
Outdoor	Duvet	Daily Fast 60'

Washing Temperature

Cool	20°C	30°C
40°C	60°C	90°C

Special programmes

Outdoor	 Rapid 15'	 Wool
 Handwash	 Allergy Safe	



Display

Residual time indicator	delay start
-------------------------	-------------

Display type



Buttons/Options

Stain Level	Stain Type	Options
Save+ / Express	 Delay timer	 Spin Speed
 Temperature	 Steam	

Technical Features



Effective consumption	20% less energy consumption than energy rating A+++	Drum capacity	55 l
Type of motor	Brushless/Inverter	Door diameter	51 cm
Electronic control functioning	Yes	Door opening	160°
Programme selection knob	Yes	Automatic variable load	Yes
Spin speed selection on display/LED	No spin/ 400/ 800/ 1000/ 1200/ 1400	Antifoam system	Yes
Display/led for temperature regulation	Yes	Load balancing system	Automatic
Polypropilene tank	Yes	Easy to access filter	Yes
Basket	Stainless steel	Child lock (functions block)	Control block

Electrical Connection

Nominal power	2200 W	Frequency (Hz)	50 Hz
Current	10 A	Power supply cable length	160 cm
Voltage (V)	220-240 V	Plug	(M) Sud Africa

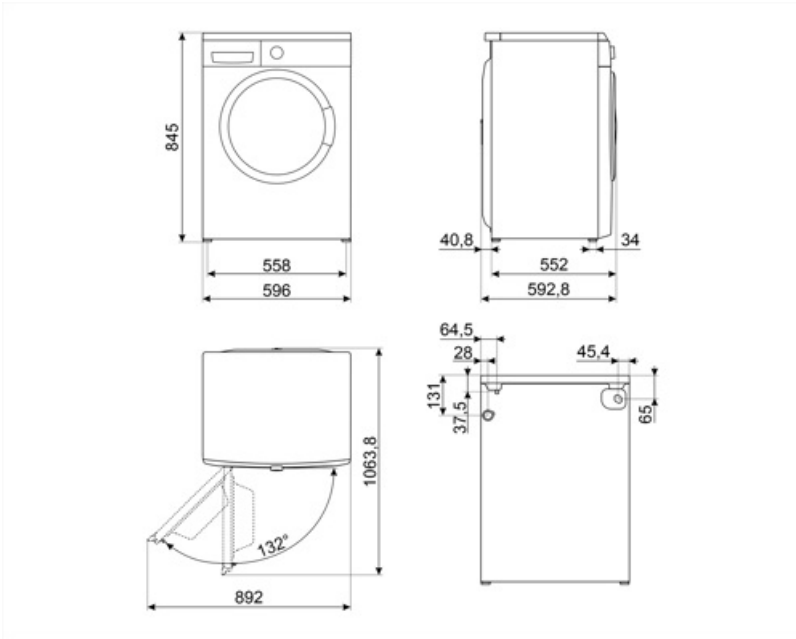





















Compatible Accessories

KITPLV2

Kit extension for dishwasher and washing machine: lenght mt. 2



Symbols glossary

 <p>Variable load: In all models of washing machines is present the system of variable load, according to which the machine automatically diversifies the wash cycle and the time of operation depending on the quantity and type of laundry introduced, allowing a significant saving of water and energy power, up to 30% compared to the versions with fixed load.</p>	 <p>Automatic Load Balancing: provides an ideal distribution of laundry in the drum. In case if the imbalance is detected, the rotation speed starts being controlled in such way to evenly redistribute laundry in the drum, and thus reduce vibration.</p>
 <p>A+++: Appliances with this symbol can reduce energy consumption by a further 30% from the standard A energy rating.</p>	 <p>Child lock: some models are fitted with a device to lock the programme/cycle so it cannot be accidentally changed.</p>
 <p>Delay timer: can be set to run the programme at a convenient time or to take advantage of off-peak energy periods.</p>	 <p>LED display: to show programmes, functions and options selected and the time to the end of the cycle.</p>
 <p>This option advises when the periodic cleaning of the filters is needed, in order to avoid forgetfulness and thus guarantee the perfect functioning of the dryer over time. The convenient position of the filters makes maintenance fast and extremely simple.</p>	 <p>Smeg's evolution towards more intelligent and eco-friendly models has led to the choice of Inverter technology, which significantly reduces consumption.</p>
 <p>Antiallergic: Antiallergic program with particular attention to the total removal of residual detergent.</p>	 <p>For lightly soiled fabrics in cotton and linen</p>
 <p>Cotton: For soiled fabrics in cotton</p>	 <p>Use to wash your normally soiled, durable cotton and linen laundry. Although it washes longer than all other programmes, it provides high energy and water savings. Actual water temperature may be different from the stated wash temperature. When you load the machine with less laundry (e.g. ½ capacity or less), programme time may automatically get shorter. In this case, energy and water consumption will decrease more, providing a more economic wash. This programme is available in the models with the remaining time indicator.</p>
 <p>Prewash cotton</p>	 <p>To drain the water in the machine.</p>
 <p>Hand wash: this specific programme for delicate fabrics uses slower rotations of the drum to ensure the utmost care for clothing.</p>	 <p>Super fast 15 min: a programme designed to wash small amounts of laundry fast, ideal for washing lightly soiled garments.</p>
 <p>Extra rinse: The Extra rinse option: can be added to the selected programme when more thorough cleansing of special fabrics is needed.</p>	 <p>Spin speed control: On the control panel there is a spin speed control knob. In some models, the maximum spin speed is 1400 rpm / min. You can also to exclude spin.</p>
 <p>Wool: this programme for wool or delicate fabrics uses slower rotations of the drum to ensure the utmost care for clothing.</p>	 <p>Steam Option: the steam is perfect for smoothing out creases, refreshing fabrics, neutralizing odors and releasing dirt, destroying allergens more quickly than by washing the item in water.</p>



Drum has maximum capacity of 8kg of dry laundry.



Jeans / Dark garments: Special cycle designed to meet the washing needs of jeans or dark garments. The program allows you to wash the garments respecting colors and minimizing creases thanks to minimal mechanical action and low temperatures.



Temperature Adjustment: allows you to tailor the wash cycle to your needs by selecting the most suitable temperature to protect fabrics, remove dirt, and achieve optimal results with every wash.

Benefit (TT)

Standard dimensions to fit any home environment, with optimal capacity and advanced features

15 programmes

Up to 15 programmes to meet every daily need

LED Display

With soft touch control and LED lights for intuitive and fast setting and selection of each option

Inverter

Brushless, it offers greater energy efficiency, lower consumption and longer life, reducing wear and noise. It optimises consumption and ensures high performance while maintaining high washing efficiency.

Giant door

The size of the door offers greater convenience and versatility, facilitating the loading and unloading of laundry thanks to its wide opening, and gives a more premium and elegant look, enriching the overall design of the appliance