

WM3T94SSA

EAN Code	8017709296216
Product Family	Washing Machine
Commercial width	60 cm
Commercial depth	Standard
Installation	Free-standing
Load type	Frontal











Aesthetics

Colour	Silver	Programme/temperature knob colour	Chrome
Front panel colour	Silver	Door colour	Black with chrome ring
Led/display colour	White	Door window	Giant door
Front panel type	T3	Handle colour	Chrome
Function buttons colour	Cromato	Drawer Color	Chrome
On/Off buttons colour	Cromato	Cabinet colour	Silver
No. of control knobs	1	Top colour	Silver

Programs

Controls	Electronic
Programmes graphics	Written in EN
No. of programmes	15





Programmes

 Anti-allergy	 Cotton 40°	 Cotton 60°
 Cotton Prewash	Eco 20°	 Jeans/Capi scuri
 Wool	 Hand Wash	Outdoor
Duvet	Daily Fast 60'	 Quick wash 15 min
 Rinse	 Drain + Spin	 Synthetics

Washing Temperature

Cool	20°C	30°C
40°C	60°C	90°C

Special programmes

Outdoor	 Anti-allergy	 Wool
 Handwash	 Quick 15 min	



Display

Residual time indicator delay start

Display type



Buttons/Options

Stain Level	Stain Type	Options
Save+ / Express	 Delay timer	 Spin Speed

 Temperature

End of cycle indicator (light) On display

Technical Features



Effective consumption	20% less energy consumption than energy rating A+++	Door diameter	33 cm
Type of motor	Brushless/Inverter	Door opening	160°
Electronic control functioning	Yes	Automatic variable load	Yes
		Antifoam system	Yes
		Load balancing system	Automatic
		Easy to access filter	Yes

Programme selection knob	Yes	Child lock (functions block)	Control block
Spin speed selection on display/LED	No spin/ 400/ 800/ 1000/ 1200/ 1400	Anti-flood system	Yes
Display/led for temperature regulation	Yes		
Polypropilene tank	Yes		
Basket	Stainless steel		
Drum capacity	61 l		

Electrical Connection

Nominal power	2200 W	Frequency (Hz)	50 Hz
Current	10 A	Power supply cable length	160 cm
Voltage (V)	220-240 V	Plug	(M) Sud Africa

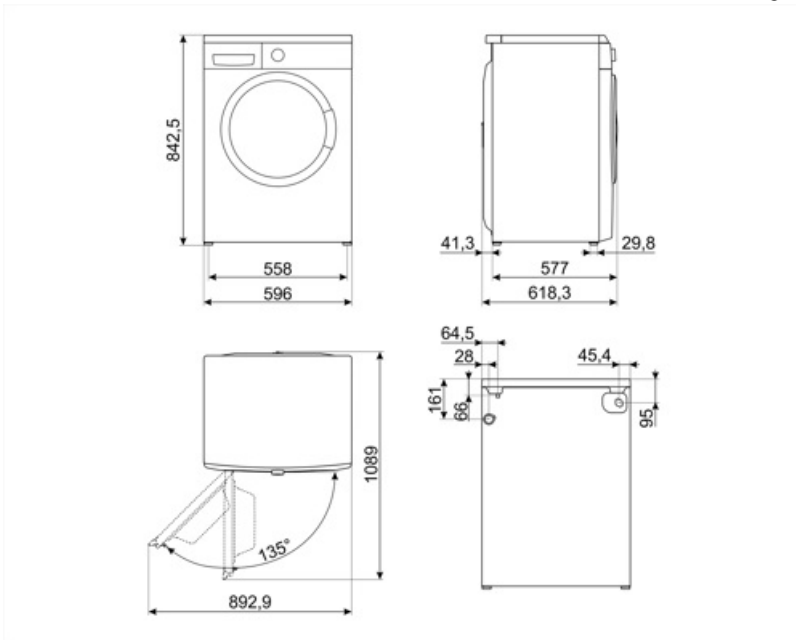



















Compatible Accessories

KITPLV2

Kit extension for dishwasher and washing machine: lenght mt. 2



Symbols glossary

-  A+++: Appliances with this symbol can reduce energy consumption by a further 30% from the standard A energy rating.
-  Automatic Load Balancing: provides an ideal distribution of laundry in the drum. In case if the imbalance is detected, the rotation speed starts being controlled in such way to evenly redistribute laundry in the drum, and thus reduce vibration.
-  Delay timer: can be set to run the programme at a convenient time or to take advantage of off-peak energy periods.
-  33 cm: Large loading hatch of 30-32-33 cm in diameter, makes laundry loading and unloading easier and faster with maximum ease of use.
-  Smeg's evolution towards more intelligent and eco-friendly models has led to the choice of Inverter technology, which significantly reduces consumption.
-  Cotton 40°: For soiled fabrics in cotton
-  Prewash cotton
-  Hand wash: this specific programme for delicate fabrics uses slower rotations of the drum to ensure the utmost care for clothing.
-  Extra rinse: The Extra rinse option: can be added to the selected programme when more thorough cleansing of special fabrics is needed.
-  Variable load: In all models of washing machines is present the system of variable load, according to which the machine automatically diversifies the wash cycle and the time of operation depending on the quantity and type of laundry introduced, allowing a significant saving of water and energy power, up to 30% compared to the versions with fixed load.
-  Child lock: some models are fitted with a device to lock the programme/cycle so it cannot be accidentally changed.
-  LED display: to show programmes, functions and options selected and the time to the end of the cycle.
-  This option advises when the periodic cleaning of the filters is needed, in order to avoid forgetfulness and thus guarantee the perfect functioning of the dryer over time. The convenient position of the filters makes maintenance fast and extremely simple.
-  Antiallergic: Antiallergic program with particular attention to the total removal of residual detergent.
-  Cotton 60°: For soiled fabrics in cotton
-  To drain the water in the machine.
-  Super fast 15 min: a programme designed to wash small amounts of laundry fast, ideal for washing lightly soiled garments.
-  Spin speed control: On the control panel there is a spin speed control knob. In some models, the maximum spin speed is 1400 rpm / min. You can also to exclude spin.



Synthetics: to wash your synthetic clothes (shirts, blouses, synthetic/cotton blends, etc.). It washes with a gentle action and has a shorter washing cycle compared to the Cottons programme. For curtains and tulle, use the Synthetic 40°C programme with prewash and anti-creasing functions selected. As their meshed texture causes excessive foaming, wash the veils/tulle by putting little amount of detergent into the main wash compartment. Do not put detergent in the prewash compartment.



Wool: this programme for wool or delicate fabrics uses slower rotations of the drum to ensure the utmost care for clothing.



Drum has maximum capacity of 9kg of dry laundry.



Jeans / Dark garments: Special cycle designed to meet the washing needs of jeans or dark garments. The program allows you to wash the garments respecting colors and minimizing creases thanks to minimal mechanical action and low temperatures.



Temperature Adjustment: allows you to tailor the wash cycle to your needs by selecting the most suitable temperature to protect fabrics, remove dirt, and achieve optimal results with every wash.

Benefit (TT)

Standard dimensions to fit any home environment, with optimal capacity and advanced features

15 programmes

Up to 15 programmes to meet every daily need

LED Display

With soft touch control and LED lights for intuitive and fast setting and selection of each option

Inverter

Brushless, it offers greater energy efficiency, lower consumption and longer life, reducing wear and noise. It optimises consumption and ensures high performance while maintaining high washing efficiency.

Giant door

The size of the door offers greater convenience and versatility, facilitating the loading and unloading of laundry thanks to its wide opening, and gives a more premium and elegant look, enriching the overall design of the appliance