

WMFABPK-2



EAN Code 8017709229726
Product Family Washing Machine
Commercial width 60 cm
Commercial depth Large capacity
Installation Free-standing
Load type Frontal



Programmes

Controls

Programmes graphics

No. of programmes

Programmes

 Softener

 Cotton ECO

 Wool

 Night

 Drain + Spin

 Shirts

 Delicates

 Hand Wash

 Quick Wash

 Synthetics

Electronic

Symbols

15

 Cotton

 Jeans

 Mix

 Rinse + Spin

 Sport

Washing Temperature

Cool 30°C 40°C

60°C 75°C 90°C

Special programmes

 Shirts

 Quick 15 min

 Jeans

 Sport

 Night









Display

Residual time indicator	delay start	Recommended load indicator
programme status indication	spin regulation	temperature regulation

Display type



Buttons/Options

 Delay timer	 FlexiTime	 Prewash
 Additional rinse	 No spin	 Anti-wrinkle (easy ironing)
 Intensive	 Cold wash	

Programme progress indicator (light)	On display
End of cycle indicator (light)	On display

Technical Features



Type of motor	Standard	Door diameter	30 cm
Electronic control functioning	Yes	Door opening	110°
Programme selection knob	Yes	Automatic variable load	Yes
Spin speed selection on display/LED	No spin/ 600/ 800/ 1000/ 1200/ 1400	Antifoam system	Yes
Display/led for temperature regulation	Yes	Load balancing system	Automatic
Polypropilene tank	Yes	Easy to access filter	Yes
Basket	Stainless steel	Child lock (functions block)	Control block
Drum capacity	54 l	Anti-flood system	Yes
Liquid detergent accessory as standard	Yes	Aquastop system	Total

Performance / Energy Label

Supplier's name or trademark	SMEG
------------------------------	------

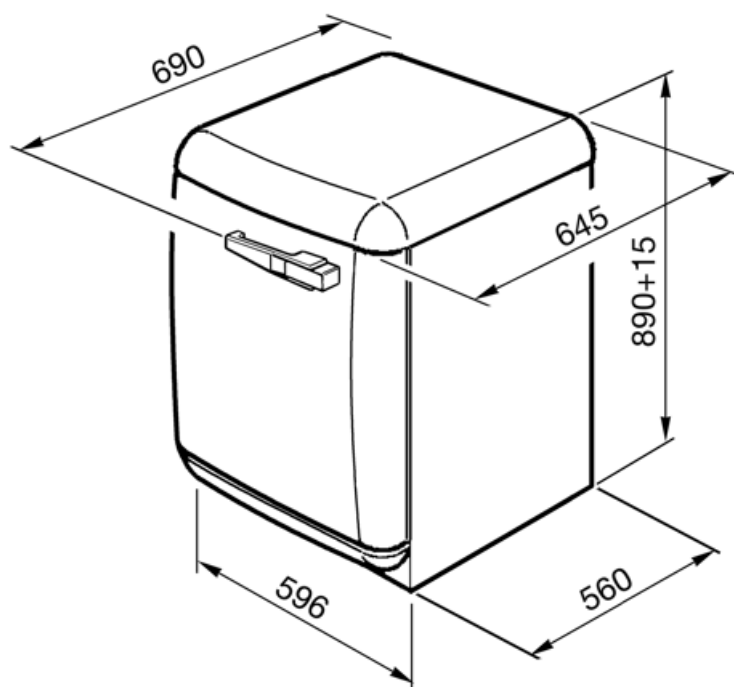

















Compatible Accessories



















KITPLV2

Kit extension for dishwasher and washing machine: length mt. 2



Symbols glossary

 <p>Total acquastop: Most models of Smeg dishwashers are equipped with Acquastop Totale, which allows to avoid flooding as a result of water leakage. The system consists of a float sensor, disposed under the inner chamber of a dishwasher, which blocks water supply inside the appliance in case of water leakage into the lower tray. An additional electromagnetic valve on the water inlet hose also automatically blocks water supply if detecting water leakage in the hose. For Laundry: Total acquastop, the product is built with 3 levels of anti-flood devices to ensure protection against water leakage. For Laundry: Total acquastop, the product is built with 3 levels of anti-flood devices to ensure protection against water leakage.</p>	 <p>Easy Iron: this is an option which can be selected to ensure the finished laundry is left with less creases to make ironing easier.</p>
 <p>Variable load: In all models of washing machines is present the system of variable load, according to which the machine automatically diversifies the wash cycle and the time of operation depending on the quantity and type of laundry introduced, allowing a significant saving of water and energy power, up to 30% compared to the versions with fixed load.</p>	 <p>Automatic Load Balancing: provides an ideal distribution of laundry in the drum. In case if the imbalance is detected, the rotation speed starts being controlled in such way to evenly redistribute laundry in the drum, and thus reduce vibration.</p>
 <p>Child lock: some models are fitted with a device to lock the programme/cycle so it cannot be accidentally changed.</p>	 <p>A++: Energy efficiency class A++ helps to save up to 20% energy compared to class A. Maximum performance with minimum consumption is guaranteed.</p>
 <p>Cold wash</p>	 <p>Delay timer: can be set to run the programme at a convenient time or to take advantage of off-peak energy periods.</p>
 <p>LED display: to show programmes, functions and options selected and the time to the end of the cycle.</p>	 <p>30 cm: Large loading hatch of 30-32-33 cm in diameter, makes laundry loading and unloading easier and faster with maximum ease of use.</p>
 <p>This option advises when the periodic cleaning of the filters is needed, in order to avoid forgetfulness and thus guarantee the perfect functioning of the dryer over time. The convenient position of the filters makes maintenance fast and extremely simple.</p>	 <p>FlexiTime: The FlexiTime option allows the user to reduce the time of the cycle selected, providing extra flexibility and control.</p>
 <p>Intensive: this option intensifies the selected program. Cycle duration and water consumption are reduced by taking into account the type of laundry, while still guaranteeing excellent washing results, even in the case of stains that are difficult to eliminate.</p>	 <p>No spin option: this option allows to exclude the last spin phase, draining the water from the tank</p>
 <p>Prewash: program designed for heavily soiled garments.</p>	 <p>Cotton: For soiled fabrics in cotton</p>

- | | |
|--|--|
|  <p>Use to wash your normally soiled, durable cotton and linen laundry. Although it washes longer than all other programmes, it provides high energy and water savings. Actual water temperature may be different from the stated wash temperature. When you load the machine with less laundry (e.g. ½ capacity or less), programme time may automatically get shorter. In this case, energy and water consumption will decrease more, providing a more economic wash. This programme is available in the models with the remaining time indicator.</p> |  <p>Delicate: Clothing such as underwear, hosiery and luxury fabrics should be dried on the delicate cycle to help extend the life of the clothing.</p> |
|  <p>To drain the water in the machine.</p> |  <p>Extra Rinse: Extra Rinse: adds an extra rinse cycle to that already provided in the program chosen, to remove any residual detergent. This function is particularly suitable for those with allergies or skin problems.</p> |
|  <p>Hand wash: this specific programme for delicate fabrics uses slower rotations of the drum to ensure the utmost care for clothing.</p> |  <p>Jeans: a washing cycle which is kind to the colour and fabric of denim whilst minimising wrinkles.</p> |
|  <p>Mixed fabrics: this cycle is designed for lightly soiled laundry in a mix of cottons and synthetics, or can be used just to refresh stored items.</p> |  <p>Night: an ideal programme for those who want to take advantage of off-peak energy periods, this cycle is particularly quiet due to slower rotations of the drum.</p> |
|  <p>Super fast 15 min: a programme designed to wash small amounts of laundry fast, ideal for washing lightly soiled garments.</p> |  <p>Super fast: a programme designed to wash small amounts of laundry fast, ideal for washing lightly soiled garments.</p> |
|  <p>To drain the water into the basket + centrifuge action</p> |  <p>Shirts: a cycle to wash shirts in a short time with the utmost care, using a delicate spin for easy ironing.</p> |
|  <p>Softener</p> |  <p>Gym: Gym, a cycle designed for washing lightly soiled garments, ie sports wear, this is a fast wash which is also kind to fabrics.</p> |
|  <p>Synthetics: to wash your synthetic clothes (shirts, blouses, synthetic/cotton blends, etc.). It washes with a gentle action and has a shorter washing cycle compared to the Cottons programme. For curtains and tulle, use the Synthetic 40°C programme with prewash and anti-creasing functions selected. As their meshed texture causes excessive foaming, wash the veils/tulle by putting little amount of detergent into the main wash compartment. Do not put detergent in the prewash compartment.</p> |  <p>Wool: this programme for wool or delicate fabrics uses slower rotations of the drum to ensure the utmost care for clothing.</p> |
|  <p>Volumeplus: Smeg offers models with load up to 8 kg, while maintaining the best washing results, and providing low energy consumption.</p> |  <p>Drum has maximum capacity of 7kg of dry laundry.</p> |