

WMI147C

EAN Code	8017709302825
Product Family	Washing Machine
Commercial width	60 cm
Commercial depth	Standard
Installation	Fully integrated built-in
Load type	Frontal



Aesthetics

Colour	White	No. of control knobs	1
Front panel colour	White	Programme/temperature knob colour	White
Led/display colour	Green	Door colour	White
Front panel type	Smeg LI 2010	Door window	Standard
Display frame colour	White	Handle colour	White
Function buttons colour	White	Drawer Color	White
On/Off buttons colour	White	Cabinet colour	White

Programs

Controls	Electronic
Programmes graphics	Written in EN
No. of programmes	15

Programmes

Cotton 20°	Cotton 40°	Cotton 60°
Cotton 90°	Delicate 30°	Eco 40-60
Wool 30°	Wool Cold	Mix 30°
Quick Wash 15' 30°	Rinse + Spin	Drain + Spin
Synthetics 30°	Synthetics 40°	Synthetics Cold

Washing Temperature

Cool	20°C	30°C
40°C	60°C	90°C

Special programmes

Wool	Mix	Quick 30 min
Sport		

Display

Residual time indicator	delay start	Recommended load indicator
programme status indication		

Display type



Buttons/Options

Delay timer	Prewash	Additional rinse
No spin	Rinse hold	Anti-wrinkle (easy ironing)
Intensive		

On/off indicator (light)

Yes

Programme progress indicator (light)

On display

End of cycle indicator (light)



Technical Features



Type of motor	Standard	Door diameter	30 cm
Electronic control functioning	Yes	Door opening	110°
Programme selection knob	Yes	Automatic variable load	Yes
Programme/temperature selection knob	Yes	Antifoam system	Yes
Spin speed selection on display/LED	No spin/ 600/ 800/ 1000/ 1200/ 1400	Load balancing system	Automatic
Polypropilene tank	Yes	Easy to access filter	Yes
Basket	Stainless steel	Child lock (functions block)	Control block
Drum capacity	52 l	Anti-flood system	Yes
Liquid detergent accessory as standard	Yes	Furniture door can be fitted on right or left side with adjustable hinges	Yes

Performance / Energy Label - Reg. 2019



Supplier's name or trademark	SMEG	Spin-drying efficiency class	B
Rated Capacity	7 kg	Airbone acoustical noise class	A
Energy Efficiency Class	E	Airbone acoustical noise	72 dB(A) re 1 pW
Energy_cons_100	77 kWh	Programme duration at rated capacity	2:50 h:min
Water Consumption	44 litres		

Electrical Connection

Nominal power	2000 W	Frequency (Hz)	50 Hz
Current	10 A	Power supply cable length	175 cm
Voltage (V)	220-240 V	Plug	(G) UK e Singapore

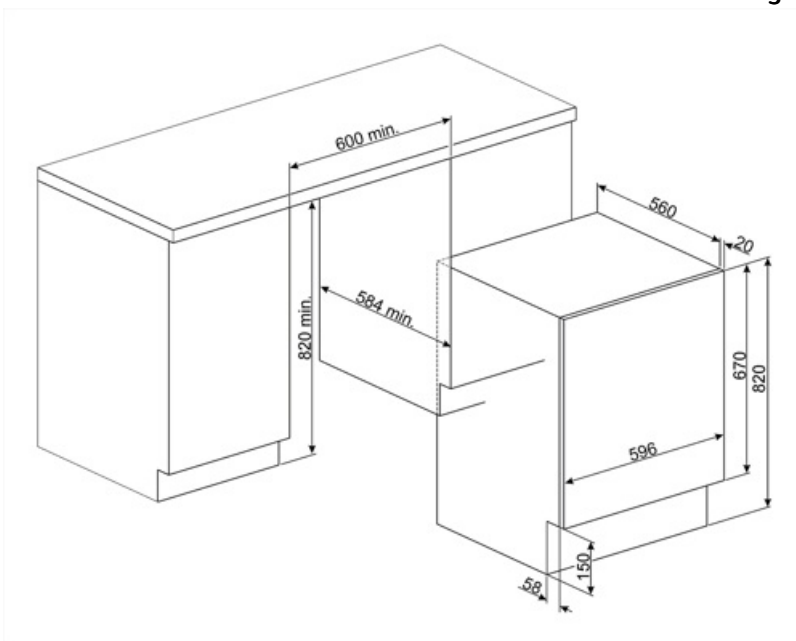

Compatible Accessories



KITPLV2





















Kit extension for dishwasher and washing machine: lenght mt. 2



















KITWDHE1

5 cm raising kit for built-in washing machines and washer dryers

Symbols glossary

 <p>A++: Energy efficiency class A++ helps to save up to 20% energy compared to class A. Maximum performance with minimum consumption is guaranteed.</p>	 <p>Easy Iron: this is an option which can be selected to ensure the finished laundry is left with less creases to make ironing easier.</p>
 <p>Variable load: In all models of washing machines is present the system of variable load, according to which the machine automatically diversifies the wash cycle and the time of operation depending on the quantity and type of laundry introduced, allowing a significant saving of water and energy power, up to 30% compared to the versions with fixed load.</p>	 <p>Automatic Load Balancing: provides an ideal distribution of laundry in the drum. In case if the imbalance is detected, the rotation speed starts being controlled in such way to evenly redistribute laundry in the drum, and thus reduce vibration.</p>
 <p>Acoustic signal: informs about the end of the drying cycle, in order to to get things out in time and avoid excessive creasing.</p>	 <p>Child lock: some models are fitted with a device to lock the programme/cycle so it cannot be accidentally changed.</p>
 <p>Delay timer: can be set to run the programme at a convenient time or to take advantage of off-peak energy periods.</p>	 <p>LED display: to show programmes, functions and options selected and the time to the end of the cycle.</p>
 <p>30 cm: Large loading hatch of 30-32-33 cm in diameter, makes laundry loading and unloading easier and faster with maximum ease of use.</p>	 <p>This option advises when the periodic cleaning of the filters is needed, in order to avoid forgetfulness and thus guarantee the perfect functioning of the dryer over time. The convenient position of the filters makes maintenance fast and extremely simple.</p>
 <p>Intensive option: this function extends the duration of the wash cycle and increases the intensity of the wash, ensuring a deeper cleaning for heavily soiled garments.</p>	 <p>No spin option: this option allows to exclude the last spin phase, draing the water from the tank</p>
 <p>Prewash: program designed for heavily soiled garments.</p>	 <p>For lightly soiled fabrics in cotton and linen</p>
 <p>Cotton 40°: For soiled fabrics in cotton</p>	 <p>Cotton 60°: For soiled fabrics in cotton</p>
 <p>Cotton 90°: For soiled fabrics in cotton</p>	 <p>Eco 40-60: reference programme defined by EU regulations for measuring the energy performance of washing machines. Ideal for normally soiled cotton garments washable at 40 °C or 60 °C, it provides an excellent balance between cleaning performance and savings, although it requires a longer washing time.</p>
 <p>Delicate 30°: Clothing such as underwear, hosiery and luxury fabrics should be dried on the delicate cycle to help extend the life of the clothing.</p>	 <p>To drain the water in the machine.</p>

- | | |
|---|---|
|  <p>Extra Rinse: Extra Rinse: adds an extra rinse cycle to that already provided in the program chosen, to remove any residual detergent. This function is particularly suitable for those with allergies or skin problems.</p> |  <p>Mix 30°: washing program that allows to wash your cotton and synthetic clothes together without sorting them.</p> |
|  <p>Mixed fabrics: this cycle is designed for lightly soiled laundry in a mix of cottons and synthetics, or can be used just to refresh stored items.</p> |  <p>Rapid 15-30 ° : Rapid washing program at 30 °, let to clean slightly dirty items in a very short time.</p> |
|  <p>Super fast 30 min: a programme designed to wash small amounts of laundry fast, ideal for washing lightly soiled garments.</p> |  <p>Terminato il lavaggio il ciclo si blocca con l'acqua in vasca</p> |
|  <p>Rinse and Spin: this programme is suitable for rinsing and spinning garments.</p> |  <p>Sport: programme designed to quickly wash sports and technical clothing, which undergo frequent washes, ensuring optimal hygiene and protection of the fibres.</p> |
|  <p>Synthetic 30 °: washing program at 30 ° for Synthetics items</p> |  <p>Synthetic 40 °: washing program at 30 ° for Synthetics items</p> |
|  <p>Synthetics: Synthetics washing program is designed for non-cotton items that need a slightly more delicate wash</p> |  <p>Wool 30°: this programme for wool or delicate fabrics uses slower rotations of the drum to ensure the utmost care for clothing.</p> |
|  <p>Wool: this programme for wool or delicate fabrics uses slower rotations of the drum to ensure the utmost care for clothing.</p> |  <p>Wool Cold: this programme for wool or delicate fabrics uses slower rotations of the drum to ensure the utmost care for clothing.</p> |
|  <p>Drum has maximum capacity of 7kg of dry laundry.</p> |  <p>Energy efficiency class E</p> |

Benefit (TT)

Standard dimensions to fit any home environment, with optimal capacity and advanced features

15 programmes

Up to 15 programmes to meet every daily need

LED Display

With soft touch control and LED lights for intuitive and fast setting and selection of each option