

WNP04SEAIN

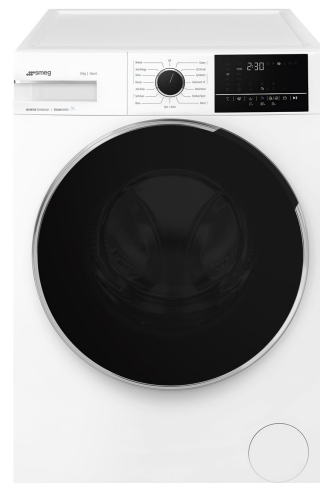

EAN Code	8017709328238
Product Family	Washing Machine
Commercial width	60 cm
Commercial depth	Large capacity
Installation	Free-standing
Load type	Frontal



Programme / Functions

Controls	Electronic
Programmes graphics	Written in EN
Multilanguage clip system	Yes
No. of programmes	15



Programmes

 Anti-allergy	Stain-resistant	 Shirts
 Cotton	Eco 40-60	Wool/Hand wash
 Mix	Outdoor	Duvet
 Quick Wash 14 min	 Refresh	 Rinse
 Drain + Spin	Self Clean	 Synthetics

Washing Temperature

Cool	20°C	30°C
40°C	60°C	90°C

Special programmes

Outdoor	Refresh	 Anti-allergy
Antimacchia	 Quick 14 min	

Display

Residual time indicator delay start programme status indication

Display type



Buttons/Options

End Time

Spin Speed

Temperature



Prewash



Quick



Steam

Programme progress indicator (light)

On display

End of cycle indicator (light)

On display

Technical Features



Type of motor Brushless/Inverter
 Electronic control Yes
 functioning
 Programme selection Yes
 knob
 Spin speed selection on No spin/ 600/ 800/ 1200/
 display/LED 1400/ Rinse hold
 Display/led for Yes
 temperature regulation
 Polypropilene tank Yes
 Basket Stainless steel
 Drum capacity 65 l

Liquid detergent Yes
 accessory as standard
 Door diameter 34 cm
 Door opening 160°
 Automatic variable load Yes
 Antifoam system Yes
 Load balancing system Automatic
 Easy to access filter Yes
 Child lock (functions Control block
 block)

Performance / Energy Label NEW 2019



Supplier's name or SMEG
 trademark
 Rated Capacity 10 kg
 Energy Efficiency Class A
 Energy_cons_100 51 KWh
 Water Consumption 48 litres
 Spin-drying efficiency B
 class
 Airbone acoustical noise B
 class
 Airbone acoustical noise 75 dB(A) re 1 pW
 Programme duration at 3:58 h:min
 rated capacity

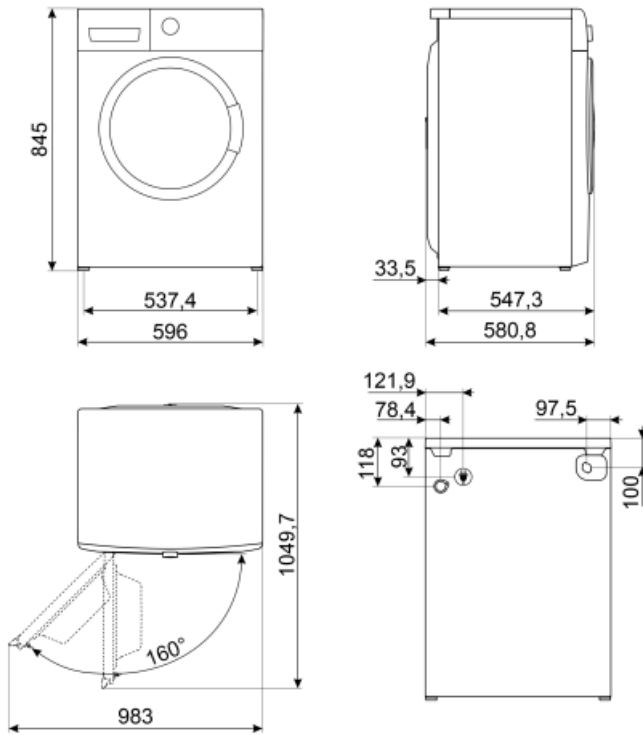



















Not included accessories

KITPLV2

Kit extension for dishwasher and washing machine: lenght mt. 2



Symbols glossary (TT)

 <p>Variable load: In all models of washing machines is present the system of variable load, according to which the machine automatically diversifies the wash cycle and the time of operation depending on the quantity and type of laundry introduced, allowing a significant saving of water and energy power, up to 30% compared to the versions with fixed load.</p>	 <p>Automatic Load Balancing: provides an ideal distribution of laundry in the drum. In case if the imbalance is detected, the rotation speed starts being controlled in such way to evenly redistribute laundry in the drum, and thus reduce vibration.</p>
 <p>Child lock: some models are fitted with a device to lock the programme/cycle so it cannot be accidentally changed.</p>	 <p>LED display: to show programmes, functions and options selected and the time to the end of the cycle.</p>
 <p>34 cm: Large loading hatch of 34 cm in diameter, makes laundry loading and unloading easier and faster with maximum ease of use.</p>	 <p>This option advises when the periodic cleaning of the filters is needed, in order to avoid forgetfulness and thus guarantee the perfect functioning of the dryer over time. The convenient position of the filters makes maintenance fast and extremely simple.</p>
 <p>Smeg's evolution towards more intelligent and eco-friendly models has led to the choice of Inverter technology, which significantly reduces consumption.</p>	 <p>Prewash: program designed for heavily soiled garments.</p>
 <p>Antiallergic: Antiallergic program with particular attention to the total removal of residual detergent.</p>	 <p>Cotton: For soiled fabrics in cotton</p>
 <p>To drain the water in the machine.</p>	 <p>Mixed fabrics: this cycle is designed for lightly soiled laundry in a mix of cottons and synthetics, or can be used just to refresh stored items.</p>
 <p>Super fast 14 min.: a programme designed to wash small amounts of laundry fast, ideal for washing lightly soiled garments.</p>	 <p>Refresh: an ideal program to refresh the garments that have been kept for a long time indoors and eliminate unpleasant odors, without having to wash.</p>
 <p>Extra rinse: The Extra rinse option: can be added to the selected programme when more thorough cleansing of special fabrics is needed.</p>	 <p>Shirts: a cycle to wash shirts in a short time with the utmost care, using a delicate spin for easy ironing.</p>
 <p>Synthetics: to wash your synthetic clothes (shirts, blouses, synthetic/cotton blends, etc.). It washes with a gentle action and has a shorter washing cycle compared to the Cottons programme. For curtains and tulle, use the Synthetic 40°C programme with prewash and anti-creasing functions selected. As their meshed texture causes excessive foaming, wash the veils/tulle by putting little amount of detergent into the main wash compartment. Do not put detergent in the prewash compartment.</p>	 <p>Option that allow to reduce times of the selected program.</p>



Steam Option: the steam is perfect for smoothing out creases, refreshing fabrics, neutralizing odors and releasing dirt, destroying allergens more quickly than by washing the item in water.



Volumeplus: Smeg offers models with load up to 8 kg, while maintaining the best washing results, and providing low energy consumption.



Energy efficiency class A



Drum has maximum capacity of 10kg of dry laundry.