

WNP84SEAUK

EAN Code	8017709347222
Product Family	Washing Machine
Commercial width	60 cm
Commercial depth	Standard capacity
Installation	Free-standing
Load type	Frontal



Aesthetics

Colour	White	Programme/temperature knob colour	Black/Chrome
Front panel colour	White	Door colour	Black with chrome ring
Led/display colour	White	Door window	Giant 51cm
Front panel type	NovaCare	Handle colour	Black
Function button colour	Black	Drawer Colour	Chrome
On/Off button colour	Black	Cabinet colour	White
No. of control knobs	1	Top colour	White

Programmes

Controls	Electronic
Programmes graphics	Written in EN
No. of programmes	15

Programmes

Anti-allergy	Stain-resistant	Shirts
Cotton	Eco 40-60	Wool/Hand wash
Mix	Outdoor	Duvet
Quick Wash 14 min	Refresh	Rinse
Drain + Spin	Self Clean	Synthetics

Washing Temperature

Cool	20°C	30°C
40°C	60°C	90°C

Special programmes

Outdoor	Refresh	Anti-allergy
Stain resistant	Wool	

Display

Residual time indicator	delay start
-------------------------	-------------

Display type



Buttons/Options

Delay timer	Spin Speed	Temperature
Prewash	Quick	Steam

Programme progress indicator (light)

Lights

End of cycle indicator (light)

On display

Technical Features



Type of motor	Brushless/Inverter	Liquid detergent accessory as standard	Yes
Electronic control functioning	Yes	Door diameter	34 cm
Programme selection knob	Yes	Door opening	160°
Spin speed selection on display/LED	No spin/ 600/ 800/ 1200/ 1400/ Rinse hold	Automatic variable load	Yes
		Antifoam system	Yes
		Load balancing system	Automatic

Display/led for temperature regulation	Yes	Easy to access filter	Yes
Polypropilene tank	Yes	Child lock (functions block)	Control block
Basket	Stainless steel		
Drum capacity	55 l		

Performance / Energy Label



Supplier's name or trademark	SMEG	Spin-drying efficiency class	B
Rated Capacity	8 kg	Airbone acoustical noise class	B
Energy Efficiency Class	A	Airbone acoustical noise	76 dB(A) re 1 pW
Energy_cons_100	47 kWh	Programme duration at rated capacity	3:38 h:min
Water Consumption	47 litres		

Electrical Connection

Nominal power	2200 W	Frequency (Hz)	50 Hz
Current	10 A	Power supply cable length	140 cm
Voltage (V)	230 V	Plug	(F;E) Schuko

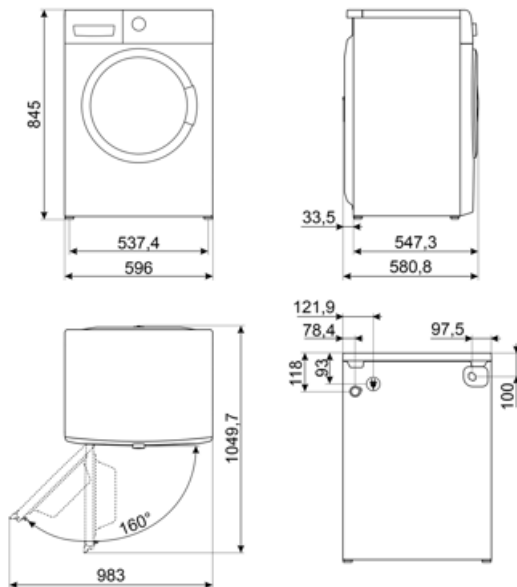

Compatible Accessories



KITPLV2

Kit extension for dishwasher and washing machine: length mt. 2





















KITSPNC











Stacking kit dedicated to WN & DN



KITSPNC1

Symbols glossary

 <p>Variable load: In all models of washing machines is present the system of variable load, according to which the machine automatically diversifies the wash cycle and the time of operation depending on the quantity and type of laundry introduced, allowing a significant saving of water and energy power, up to 30% compared to the versions with fixed load.</p>	 <p>Automatic Load Balancing: provides an ideal distribution of laundry in the drum. In case if the imbalance is detected, the rotation speed starts being controlled in such way to evenly redistribute laundry in the drum, and thus reduce vibration.</p>
 <p>Child lock: some models are fitted with a device to lock the programme/cycle so it cannot be accidentally changed.</p>	 <p>Delay timer: can be set to run the programme at a convenient time or to take advantage of off-peak energy periods.</p>
 <p>LED display: to show programmes, functions and options selected and the time to the end of the cycle.</p>	 <p>34 cm: Large loading hatch of 34 cm in diameter, makes laundry loading and unloading easier and faster with maximum ease of use.</p>
 <p>This option advises when the periodic cleaning of the filters is needed, in order to avoid forgetfulness and thus guarantee the perfect functioning of the dryer over time. The convenient position of the filters makes maintenance fast and extremely simple.</p>	 <p>Inverter technology: The evolution of Smeg's driers towards more intelligent and environmentally sustainable models has led to the choice of using Inverter technology with heat pumps, which reduces significantly energy consumption.</p>
 <p>Prewash: program designed for heavily soiled garments.</p>	 <p>Antiallergic: Antiallergic program with particular attention to the total removal of residual detergent.</p>
 <p>Cotton: For soiled fabrics in cotton</p>	 <p>Use to wash your normally soiled, durable cotton and linen laundry. Although it washes longer than all other programmes, it provides high energy and water savings. Actual water temperature may be different from the stated wash temperature. When you load the machine with less laundry (e.g. ½ capacity or less), programme time may automatically get shorter. In this case, energy and water consumption will decrease more, providing a more economic wash. This programme is available in the models with the remaining time indicator.</p>
 <p>To drain the water in the machine.</p>	 <p>Mixed fabrics: this cycle is designed for lightly soiled laundry in a mix of cottons and synthetics, or can be used just to refresh stored items.</p>
 <p>Super fast 14 min.: a programme designed to wash small amounts of laundry fast, ideal for washing lightly soiled garments.</p>	 <p>Refresh: an ideal program to refresh the garments that have been kept for a long time indoors and eliminate unpleasant odors, without having to wash.</p>
 <p>Extra rinse: The Extra rinse option: can be added to the selected programme when more thorough cleansing of special fabrics is needed.</p>	 <p>Shirts: a cycle to wash shirts in a short time with the utmost care, using a delicate spin for easy ironing.</p>

-  Spin speed control: On the control panel there is a spin speed control knob. In some models, the maximum spin speed is 1400 rpm / min. You can also to exclude spin.
-  Wool: this programme for wool or delicate fabrics uses slower rotations of the drum to ensure the utmost care for clothing.
-  Steam Option: the steam is perfect for smoothing out creases, refreshing fabrics, neutralizing odors and releasing dirt, destroying allergens more quickly than by washing the item in water.
-  ...
-  Energy efficiency class A
-  Temperature Adjustment: allows you to tailor the wash cycle to your needs by selecting the most suitable temperature to protect fabrics, remove dirt, and achieve optimal results with every wash.
-  Synthetics: to wash your synthetic clothes (shirts, blouses, synthetic/cotton blends, etc.). It washes with a gentle action and has a shorter washing cycle compared to the Cottons programme. For curtains and tulle, use the Synthetic 40°C programme with prewash and anti-creasing functions selected. As their meshed texture causes excessive foaming, wash the veils/tulle by putting little amount of detergent into the main wash compartment. Do not put detergent in the prewash compartment.
-  Option that allow to reduce times of the selected program.
-  Drum has maximum capacity of 8kg of dry laundry.
-  Wool/Hand wash: ideal program for delicate, wool and silk garments that require particular attention in washing. It uses room temperature water and slow drum rotations to ensure maximum garment care.
-  Self Clean: this programme, to be run with an empty drum, thoroughly cleans the inside of the washing machine by removing fabric and detergent residues, as well as bacteria that can accumulate during low-temperature washes.

Benefit

Standard dimensions to fit any home environment, with optimal capacity and advanced features

15 programmes

Up to 15 programmes to meet every daily need

LED Display

With soft touch control and LED lights for intuitive and fast setting and selection of each option

Steam Energy Technology

Perfectly removes stains, odours, creases, and allergens with the power of steam

Steam Energy technology, uses steam, at the beginning or end of the cycle depending on the programme, to remove stains, creases, smells and allergens.

Inverter

Brushless, it offers greater energy efficiency, lower consumption and longer life, reducing wear and noise. It optimises consumption and ensures high performance while maintaining high washing efficiency.

Giant door

The size of the door offers greater convenience and versatility, facilitating the loading and unloading of laundry thanks to its wide opening, and gives a more premium and elegant look, enriching the overall design of the appliance