

WNP84SECUK

EAN Code	8017709327538
Product Family	Washing Machine
Commercial width	60 cm
Commercial depth	Standard capacity
Installation	Free-standing
Load type	Frontal

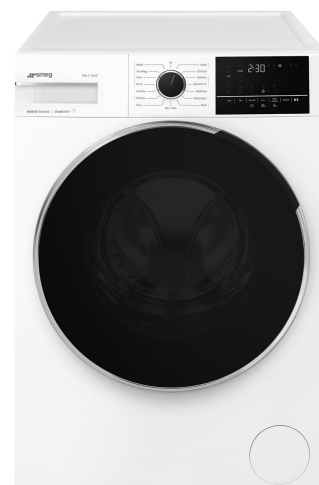

Programmes

Controls

Programmes graphics

No. of programmes

Programmes

Electronic

Written in EN



15

 Anti-allergy	 Stain-resistant	 Shirts
 Cotton	 Eco 40-60	 Wool/Hand wash
 Mix	 Outdoor	 Duvet
 Quick Wash 14 min	 Refresh	 Rinse
 Drain + Spin	 Self Clean	 Synthetics

Washing Temperature

Cool	20°C	30°C
40°C	60°C	90°C

Special programmes

Outdoor	Refresh	 Anti-allergy
Stain resistant	 Wool	

Display

Residual time indicator delay start

Display type



Buttons/Options



Delay timer

Spin Speed

Temperature



Prewash



Quick



Steam

Programme progress indicator (light)

Lights

End of cycle indicator (light)

On display

Technical Features



Type of motor Brushless/Inverter

Electronic control Yes

Programme selection knob Yes

Spin speed selection on display/LED No spin/ 600/ 800/ 1200/ 1400/ Rinse hold

Display/led for temperature regulation Yes

Polypropilene tank Yes

Basket Stainless steel

Drum capacity 55 l

Liquid detergent accessory as standard Yes

Door diameter 34 cm

Door opening 160°

Automatic variable load Yes

Antifoam system Yes

Load balancing system Automatic

Easy to access filter Yes

Child lock (functions block) Control block

Performance / Energy Label



Supplier's name or trademark SMEG

Rated Capacity 8 kg

Energy Efficiency Class C

Energy_cons_100 62 kWh

Water Consumption 46 litres

Spin-drying efficiency class B

Airbone acoustical noise class A

Airbone acoustical noise 72 dB(A) re 1 pW

Programme duration at rated capacity 3:38 h:min

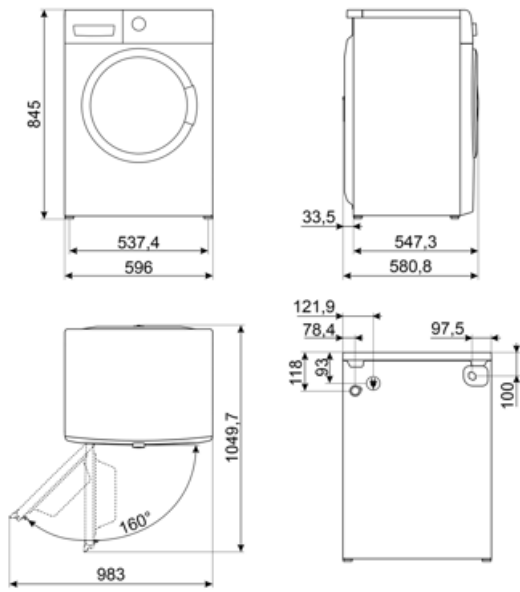



















Not included accessories

KITPLV2

Kit extension for dishwasher and washing machine: length mt. 2



Symbols glossary

 <p>Variable load: In all models of washing machines is present the system of variable load, according to which the machine automatically diversifies the wash cycle and the time of operation depending on the quantity and type of laundry introduced, allowing a significant saving of water and energy power, up to 30% compared to the versions with fixed load.</p>	 <p>Automatic Load Balancing: provides an ideal distribution of laundry in the drum. In case if the imbalance is detected, the rotation speed starts being controlled in such way to evenly redistribute laundry in the drum, and thus reduce vibration.</p>
 <p>Child lock: some models are fitted with a device to lock the programme/cycle so it cannot be accidentally changed.</p>	 <p>Energy efficiency class C</p>
 <p>Delay timer: can be set to run the programme at a convenient time or to take advantage of off-peak energy periods.</p>	 <p>LED display: to show programmes, functions and options selected and the time to the end of the cycle.</p>
 <p>34 cm: Large loading hatch of 34 cm in diameter, makes laundry loading and unloading easier and faster with maximum ease of use.</p>	 <p>This option advises when the periodic cleaning of the filters is needed, in order to avoid forgetfulness and thus guarantee the perfect functioning of the dryer over time. The convenient position of the filters makes maintenance fast and extremely simple.</p>
 <p>Inverter technology: The evolution of Smeg's driers towards more intelligent and environmentally sustainable models has led to the choice of using Inverter technology with heat pumps, which reduces significantly energy consumption.</p>	 <p>Prewash: program designed for heavily soiled garments.</p>
 <p>Antiallergic: Antiallergic program with particular attention to the total removal of residual detergent.</p>	 <p>Cleaning programme: A cleaning programme has been created to maintain the performance of washer/dryers. The display shows automatically when cleaning is required.</p>
 <p>Cotton: For soiled fabrics in cotton</p>	 <p>Use to wash your normally soiled, durable cotton and linen laundry. Although it washes longer than all other programmes, it provides high energy and water savings. Actual water temperature may be different from the stated wash temperature. When you load the machine with less laundry (e.g. ½ capacity or less), programme time may automatically get shorter. In this case, energy and water consumption will decrease more, providing a more economic wash. This programme is available in the models with the remaining time indicator.</p>
 <p>To drain the water in the machine.</p>	 <p>Mixed fabrics: this cycle is designed for lightly soiled laundry in a mix of cottons and synthetics, or can be used just to refresh stored items.</p>
 <p>Super fast 14 min.: a programme designed to wash small amounts of laundry fast, ideal for washing lightly soiled garments.</p>	 <p>Refresh: an ideal program to refresh the garments that have been kept for a long time indoors and eliminate unpleasant odors, without having to wash.</p>



Extra rinse: The Extra rinse option: can be added to the selected programme when more thorough cleansing of special fabrics is needed.



Shirts: a cycle to wash shirts in a short time with the utmost care, using a delicate spin for easy ironing.



Synthetics: to wash your synthetic clothes (shirts, blouses, synthetic/cotton blends, etc.). It washes with a gentle action and has a shorter washing cycle compared to the Cottons programme. For curtains and tulle, use the Synthetic 40°C programme with prewash and anti-creasing functions selected. As their meshed texture causes excessive foaming, wash the veils/tulle by putting little amount of detergent into the main wash compartment. Do not put detergent in the prewash compartment.



Wool: this programme for wool or delicate fabrics uses slower rotations of the drum to ensure the utmost care for clothing.



Option that allow to reduce times of the selected program.



Steam Option: the steam is perfect for smoothing out creases, refreshing fabrics, neutralizing odors and releasing dirt, destroying allergens more quickly than by washing the item in water.



Drum has maximum capacity of 8kg of dry laundry.