

# WNP96SEAUK1

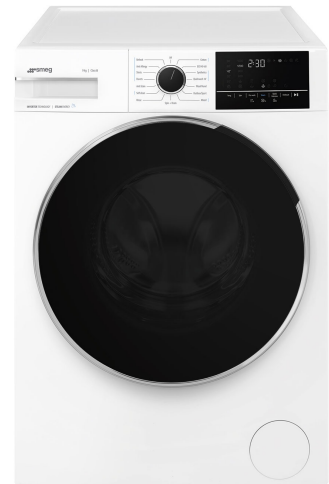

<b>EAN Code</b>	8017709347208
<b>Product Family</b>	Washing Machine
<b>Commercial width</b>	60 cm
<b>Commercial depth</b>	Large capacity
<b>Installation</b>	Free-standing
<b>Load type</b>	Frontal



## Aesthetics

<b>Colour</b>	White	<b>Programme/temperature knob colour</b>	White/Silver
<b>Front panel colour</b>	White	<b>Door colour</b>	Black with chrome ring
<b>Led/display colour</b>	White	<b>Door window</b>	Giant 51cm
<b>Front panel type</b>	NovaCare	<b>Handle colour</b>	White
<b>Function button colour</b>	Black	<b>Drawer Colour</b>	White
<b>On/Off button colour</b>	Black	<b>Cabinet colour</b>	White
<b>No. of control knobs</b>	1	<b>Top colour</b>	White

## Programmes

<b>Controls</b>	Electronic
<b>Programmes graphics</b>	Written in EN
<b>No. of programmes</b>	15

## Programmes

Cold Wash	20° C	Anti-allergy
Stain-resistant	Shirts	Cotton
Eco 40-60	Wool/Hand wash	Mix
Quick Wash 14 min	Refresh	Rinse
Drain + Spin	Self Clean	Synthetics

## Washing Temperature

Cool	20°C	30°C
40°C	60°C	90°C

## Special programmes

Refresh	Wool/Hand wash	Anti-allergy
Stain resistant	Quick 14 min	

## Display

Residual time indicator	delay start	programme status indication
-------------------------	-------------	-----------------------------

## Display type



## Buttons/Options

End Time	Spin Speed	Temperature
Quick	Steam	Smart Water

Programme progress indicator (light)	On display
End of cycle indicator (light)	On display

## Technical Features



Type of motor	Brushless/Inverter	Door diameter	34 cm
Electronic control functioning	Yes	Door opening	160°
Programme selection knob	Yes	Automatic variable load	Yes
Spin speed selection on display/LED	No spin/ 600/ 800/ 1200/ 1600/ Rinse hold	Antifoam system	Yes
		Load balancing system	Automatic
		Easy to access filter	Yes

Display/led for temperature regulation	Yes	Child lock (functions block)	Control block
Polypropilene tank	Yes	Anti-flood system	Yes
Basket	Stainless steel		
Drum capacity	65 l		
Liquid detergent accessory as standard	Yes		

## Performance / Energy Label



Supplier's name or trademark	SMEG	Spin-drying efficiency class	A
Rated Capacity	9 kg	Airbone acoustical noise class	C
Energy Efficiency Class	A	Airbone acoustical noise	78 dB(A) re 1 pW
Energy_cons_100	49 kWh	Programme duration at rated capacity	3:48 h:min
Water Consumption	49 litres		

## Electrical Connection

Nominal power	2200 W	Frequency (Hz)	50 Hz
Current	10 A	Power supply cable length	140 cm
Voltage (V)	230 V	Plug	(F;E) Schuko

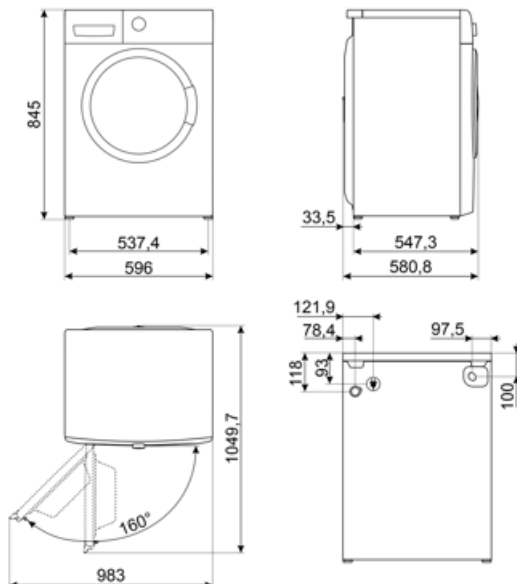

---

## Compatible Accessories

---



### KITPLV2

Kit extension for dishwasher and washing machine: length mt. 2





















### KITSPNC

Stacking kit dedicated to WN & DN



### KITSPNC1

## Symbols glossary

 <p><b>Variable load:</b> In all models of washing machines is present the system of variable load, according to which the machine automatically diversifies the wash cycle and the time of operation depending on the quantity and type of laundry introduced, allowing a significant saving of water and energy power, up to 30% compared to the versions with fixed load.</p>	 <p><b>Automatic Load Balancing:</b> provides an ideal distribution of laundry in the drum. In case if the imbalance is detected, the rotation speed starts being controlled in such way to evenly redistribute laundry in the drum, and thus reduce vibration.</p>
 <p><b>Child lock:</b> some models are fitted with a device to lock the programme/cycle so it cannot be accidentally changed.</p>	 <p><b>Cold wash</b></p>
 <p><b>LED display:</b> to show programmes, functions and options selected and the time to the end of the cycle.</p>	 <p><b>34 cm:</b> Large loading hatch of 34 cm in diameter, makes laundry loading and unloading easier and faster with maximum ease of use.</p>
 <p>This option advises when the periodic cleaning of the filters is needed, in order to avoid forgetfulness and thus guarantee the perfect functioning of the dryer over time. The convenient position of the filters makes maintenance fast and extremely simple.</p>	 <p><b>Inverter technology:</b> The evolution of Smeg's driers towards more intelligent and environmentally sustainable models has led to the choice of using Inverter technology with heat pumps, which reduces significantly energy consumption.</p>
 <p><b>Antiallergic:</b> Antiallergic program with particular attention to the total removal of residual detergent.</p>	 <p><b>Cotton:</b> For soiled fabrics in cotton</p>
 <p>Use to wash your normally soiled, durable cotton and linen laundry. Although it washes longer than all other programmes, it provides high energy and water savings. Actual water temperature may be different from the stated wash temperature. When you load the machine with less laundry (e.g. ½ capacity or less), programme time may automatically get shorter. In this case, energy and water consumption will decrease more, providing a more economic wash. This programme is available in the models with the remaining time indicator.</p>	 <p>To drain the water in the machine.</p>
 <p><b>Mixed fabrics:</b> this cycle is designed for lightly soiled laundry in a mix of cottons and synthetics, or can be used just to refresh stored items.</p>	 <p><b>Super fast 14 min.:</b> a programme designed to wash small amounts of laundry fast, ideal for washing lightly soiled garments.</p>
 <p><b>Refresh:</b> an ideal program to refresh the garments that have been kept for a long time indoors and eliminate unpleasant odors, without having to wash.</p>	 <p><b>Extra rinse:</b> The Extra rinse option: can be added to the selected programme when more thorough cleansing of special fabrics is needed.</p>
 <p><b>Shirts:</b> a cycle to wash shirts in a short time with the utmost care, using a delicate spin for easy ironing.</p>	 <p><b>Spin speed control:</b> On the control panel there is a spin speed control knob. In some models, the maximum spin speed is 1400 rpm / min. You can also to exclude spin.</p>



**Synthetics:** to wash your synthetic clothes (shirts, blouses, synthetic/cotton blends, etc.). It washes with a gentle action and has a shorter washing cycle compared to the Cottons programme. For curtains and tulle, use the Synthetic 40°C programme with prewash and anti-creasing functions selected. As their meshed texture causes excessive foaming, wash the veils/tulle by putting little amount of detergent into the main wash compartment. Do not put detergent in the prewash compartment.



Option that allow to reduce times of the selected program.



**Steam Option:** the steam is perfect for smoothing out creases, refreshing fabrics, neutralizing odors and releasing dirt, destroying allergens more quickly than by washing the item in water.



**Volumeplus:** Smeg offers models with load up to 8 kg, while maintaining the best washing results, and providing low energy consumption.



Drum has maximum capacity of 9kg of dry laundry.



...



**Wool/Hand wash:** ideal program for delicate, wool and silk garments that require particular attention in washing. It uses room temperature water and slow drum rotations to ensure maximum garment care.



Energy efficiency class A



**Self Clean:** this programme, to be run with an empty drum, thoroughly cleans the inside of the washing machine by removing fabric and detergent residues, as well as bacteria that can accumulate during low-temperature washes.



**Temperature Adjustment:** allows you to tailor the wash cycle to your needs by selecting the most suitable temperature to protect fabrics, remove dirt, and achieve optimal results with every wash.



**End Time :** this function allows you to set the desired finishing time of the wash cycle. You can plan when your laundry will be ready, aligning the end of the programme with your daily schedule while ensuring optimal washing results.

## Benefit

---

### **Large capacity**

Large capacity to handle heavy loads with advanced programs for impeccable results every wash

### **15 programmes**

Up to 15 programmes to meet every daily need

### **LED Display**

With soft touch control and LED lights for intuitive and fast setting and selection of each option

### **Steam Energy Technology**

Perfectly removes stains, odours, creases, and allergens with the power of steam

Steam Energy technology, uses steam, at the beginning or end of the cycle depending on the programme, to remove stains, creases, smells and allergens.

### **Inverter**

Brushless, it offers greater energy efficiency, lower consumption and longer life, reducing wear and noise. It optimises consumption and ensures high performance while maintaining high washing efficiency.

### **Giant door**

The size of the door offers greater convenience and versatility, facilitating the loading and unloading of laundry thanks to its wide opening, and gives a more premium and elegant look, enriching the overall design of the appliance