

WNP96SLAAUK

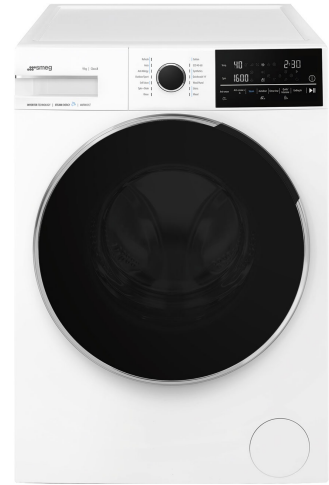













EAN Code 8017709327552
Product Family Washing Machine
Commercial width 60 cm
Commercial depth Large capacity
Installation Free-standing
Load type Frontal



Programmes



Controls Electronic
Programmes graphics Written in IT
No. of programmes 14
Programmes

- | | | |
|---|--|---|
|  Anti-allergy |  Auto Program |  Shirts |
|  Cotton |  Eco 40-60 | Wool/Hand wash |
|  Mix | Outdoor |  Quick Wash 14 min |
|  Refresh |  Rinse |  Drain + Spin |
|  Self Clean |  Synthetics | |

Washing Temperature

Cool	20°C	30°C
40°C	60°C	90°C

Special programmes

Automatic	Outdoor	Refresh
 Anti-allergy	 Quick 14 min	

Display

Residual time indicator delay start programme status indication



spin regulation temperature regulation

Display type 

Buttons/Options

End Time Anticrease+ Autodose

Extra Rinse Spin Speed Temperature

 Anti-wrinkle (easy ironing)  Quick  Steam

Programme progress indicator (light) On display
End of cycle indicator (light) On display

Technical Features



Type of motor	Brushless/Inverter	Door diameter	34 cm
Electronic control functioning	Yes	Door opening	160°
Programme selection knob	Yes	Automatic variable load	Yes
Spin speed selection on display/LED	No spin/ 600/ 800/ 1200/ 1600/ Rinse hold	Antifoam system	Yes
Display/led for temperature regulation	Yes	Load balancing system	Automatic
Polypropilene tank	Yes	Easy to access filter	Yes
Basket	Stainless steel	Child lock (functions block)	Control block
Drum capacity	65 l	Anti-flood system	Yes
Liquid detergent accessory as standard	Yes		

Performance / Energy Label NEW



Supplier's name or trademark	SMEG	Spin-drying efficiency class	A
Rated Capacity	9 kg	Airbone acoustical noise class	C
Energy Efficiency Class	A	Airbone acoustical noise	78 dB(A) re 1 pW
Energy_cons_100	49 kWh	Programme duration at rated capacity	3:48 h:min
Water Consumption	43 litres		

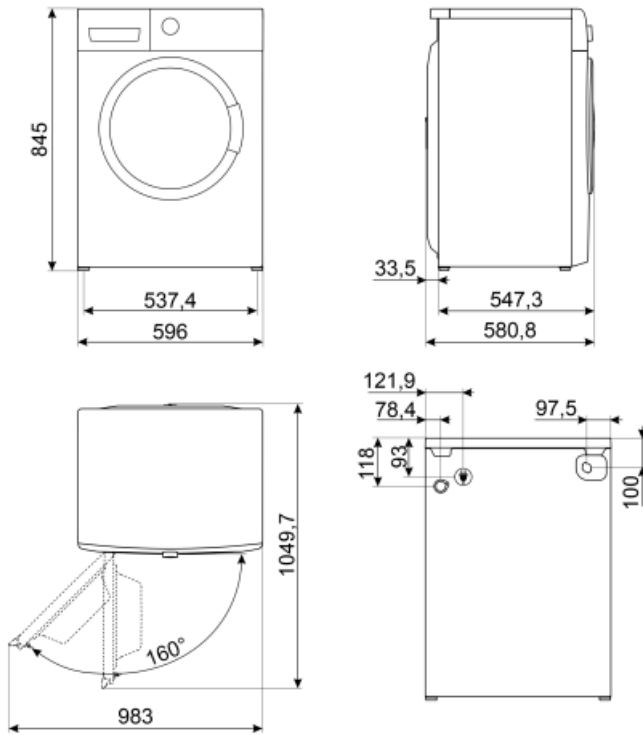



















Not included accessories

KITPLV2

Kit extension for dishwasher and washing machine: length mt. 2



Symbols glossary

 <p>Easy Iron: this is an option which can be selected to ensure the finished laundry is left with less creases to make ironing easier.</p>	 <p>Variable load: In all models of washing machines is present the system of variable load, according to which the machine automatically diversifies the wash cycle and the time of operation depending on the quantity and type of laundry introduced, allowing a significant saving of water and energy power, up to 30% compared to the versions with fixed load.</p>
 <p>Automatic Load Balancing: provides an ideal distribution of laundry in the drum. In case if the imbalance is detected, the rotation speed starts being controlled in such way to evenly redistribute laundry in the drum, and thus reduce vibration.</p>	 <p>Child lock: some models are fitted with a device to lock the programme/cycle so it cannot be accidentally changed.</p>
 <p>LCD display: to optimize performance and simplify the use of the appliance.</p>	 <p>34 cm: Large loading hatch of 34 cm in diameter, makes laundry loading and unloading easier and faster with maximum ease of use.</p>
 <p>This option advises when the periodic cleaning of the filters is needed, in order to avoid forgetfulness and thus guarantee the perfect functioning of the dryer over time. The convenient position of the filters makes maintenance fast and extremely simple.</p>	 <p>Inverter technology: The evolution of Smeg's driers towards more intelligent and environmentally sustainable models has led to the choice of using Inverter technology with heat pumps, which reduces significantly energy consumption.</p>
 <p>Antiallergic: Antiallergic program with particular attention to the total removal of residual detergent.</p>	 <p>This cycle automatically select temperature and all the washing parameters.</p>
 <p>Cleaning programme: A cleaning programme has been created to maintain the performance of washer/dryers. The display shows automatically when cleaning is required.</p>	 <p>Cotton: For soiled fabrics in cotton</p>
 <p>Use to wash your normally soiled, durable cotton and linen laundry. Although it washes longer than all other programmes, it provides high energy and water savings. Actual water temperature may be different from the stated wash temperature. When you load the machine with less laundry (e.g. ½ capacity or less), programme time may automatically get shorter. In this case, energy and water consumption will decrease more, providing a more economic wash. This programme is available in the models with the remaining time indicator.</p>	 <p>To drain the water in the machine.</p>
 <p>Mixed fabrics: this cycle is designed for lightly soiled laundry in a mix of cottons and synthetics, or can be used just to refresh stored items.</p>	 <p>Super fast 14 min.: a programme designed to wash small amounts of laundry fast, ideal for washing lightly soiled garments.</p>
 <p>Refresh: an ideal program to refresh the garments that have been kept for a long time indoors and eliminate unpleasant odors, without having to wash.</p>	 <p>Extra rinse: The Extra rinse option: can be added to the selected programme when more thorough cleansing of special fabrics is needed.</p>



Shirts: a cycle to wash shirts in a short time with the utmost care, using a delicate spin for easy ironing.



Synthetics: to wash your synthetic clothes (shirts, blouses, synthetic/cotton blends, etc.). It washes with a gentle action and has a shorter washing cycle compared to the Cottons programme. For curtains and tulle, use the Synthetic 40°C programme with prewash and anti-creasing functions selected. As their meshed texture causes excessive foaming, wash the veils/tulle by putting little amount of detergent into the main wash compartment. Do not put detergent in the prewash compartment.



Option that allow to reduce times of the selected program.



Steam Option: the steam is perfect for smoothing out creases, refreshing fabrics, neutralizing odors and releasing dirt, destroying allergens more quickly than by washing the item in water.



Volumeplus: Smeg offers models with load up to 8 kg, while maintaining the best washing results, and providing low energy consumption.



Drum has maximum capacity of 9kg of dry laundry.



Energy efficiency class A