

# ZAC8173N1F



<b>Product Family</b>	Refrigerator
<b>Installation</b>	Built-in
<b>Category</b>	Bottom Mount
<b>Built-in niche</b>	178
<b>Reference width</b>	Until 60 cm
<b>Reference height</b>	160 - 200 cm
<b>Cooling type</b>	Fan assisted refrigerator, no-frost freezer
<b>Defrost</b>	Automatic
<b>Hinge type</b>	Sliding
<b>Hinge position</b>	Right
<b>Reversible door</b>	Yes
<b>EAN code</b>	8017709331948



## Aesthetics

			
<b>Aesthetic</b>	Universale	<b>Logo</b>	Silk screen
<b>Colour</b>	White	<b>Door shelves profile color</b>	Silver
<b>Material</b>	Metal sheet	<b>Drawers profile color</b>	Silver
<b>Handle type</b>	Fixed	<b>Color of glass shelf profile</b>	Chrome
<b>Side material</b>	Steel	<b>Display</b>	LED
<b>Side colour</b>	White	<b>Display position</b>	Interno (cella frigo)

## Refrigerator compartment features

			
<b>No. of adjustable shelves</b>	4	<b>Crisper Cover</b>	Yes
<b>Number of fruit and vegetables drawers</b>	2	<b>Type of crisper/vegetable drawers cover</b>	Glass
<b>Shelves material</b>	Glass	<b>Internal light in fridge</b>	Yes
<b>Type of crisper/vegetable drawers cover</b>	Standard	<b>Type of internal light (fridge)</b>	LED

## Refrigerator Inner Door

<b>No. of door shelves with transparent cover</b>	1	<b>No. of bottle shelves</b>	1
---	---	------------------------------	---

Number of adjustable door shelves 2

## Other Refrigerator features



Accessories Egg tray Fan Yes

## Freezer compartment features

Number of drawers 3

## Other Freezer features

Accessories 1 ice box, 1 eutectic

## Other technical features



Functions display	Fast freezing
Type of temperature control	Electronic
No. of compressors	1
Refrigerant gas type	R600a
Type of compressor	Standard
Foam agent	Cyclopentane

## Performance / Energy Label - Reg. 2019

Annual energy consumption	268 kWh/a	Sum of the volumes of the frozen compartment(s)	61 l
Total net volume	254 l	Sum of the volumes of the chill compartment(s) and the unfrozen compartment(s)	193 l

## Electrical Connection

Electrical connection rating	100 W	Frequency (Hz)	50 Hz
Current	1,1 A	Power supply cable length	240 cm
Voltage (V)	220-230 V	Plug	(M) Sud Africa

## Logistic Information



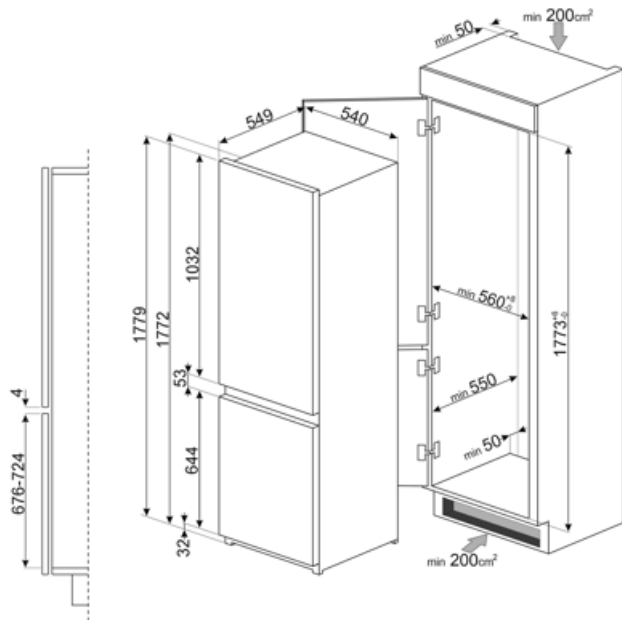



<b>Width</b>	548 mm	<b>Height</b>	1772 mm
<b>Width of the built-in niche</b>	560 mm	<b>Height of the built-in niche</b>	1780 mm
<b>Depth without handle</b>	549 mm	<b>Product width with maximum doors opening</b>	549 mm
<b>Depth of the built-in niche</b>	550 mm	<b>Spacer depth</b>	38 mm



---

## Symbols glossary

---

- |  |  |   |   |
|--|--|---|---|
|  | The automatic defrost system works by automatically defrosting at regular intervals eliminating the need to defrost altogether.            |  | LED display: to show programmes, functions and options selected and the time to the end of the cycle.                               |
|  | Ventilated: Forced distribution of cold air in the refrigerator compartment, which allows even temperature distribution within the fridge. |  | Fast freezing: The fast freezing function brings the temperature of the compartment down when activated a few hours prior to usage. |
|  | LED interior lighting: is a more energy efficient and long lasting way of illuminating the interior of the appliance.                      |  | Built-in niche  |
|  | No Frost: The No Frost and Frost free systems prevent ice from forming so that no defrosting is required.                                  |   |   |