

A4-81

Cooker size	120x60 cm
N. of cavities with energy label	2
Cavity heat source	ELECTRICITY
Hob type	Gas
Type of main oven	Thermo-ventilated
Type of second oven	Fan assisted
Cleaning system main oven	Catalytic
EAN code	8017709256807
Energy efficiency class	A
Energy efficiency class, second cavity	A

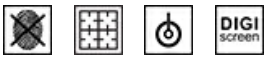

Aesthetics











Aesthetic	Classica	Type of control setting hob	Control knobs
Series	Opera	Type of control knobs	Smeg Classic
Design	Professional	Controls colour	Stainless steel
Colour	Stainless steel	No. of controls	12
Finishing	Satin	Serigraphy colour	Black
Command panel finish	Finger friendly stainless steel	Display name	DigiScreen
Logo	Assembled st/steel	Door	With 2 horizontal strips
Logo position	Facia below the oven	Glass type	Eclipse
Upstand	Yes	Handle	Smeg Classic
Hob colour	Stainless steel	Handle Colour	Brushed stainless steel
Type of pan stands	Cast Iron	Storage compartment	Drawer

Programs / Functions main oven

No. of cooking functions 8

Traditional cooking functions

 Static	 Fan assisted	 Circulaire
 Eco	 Small grill	 Large grill
 Fan grill (large)	 Fan assisted base	

Cleaning functions

Catalytic



Programs / Functions Auxiliary Oven

Cooking functions cavity 2 6

Traditional cooking functions, cavity 2



Static

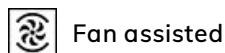

Fan assisted



Large grill

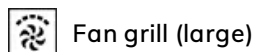

Fan grill (large)

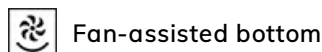

Fan-assisted bottom



Pizza

Cleaning functions cavity 2

Catalisi

Hob technical features



Total no. of cook zones 6

Front left - Gas - 2UR (dual) - 4.20 kW

Rear left - Gas - Semi Rapid - 1.80 kW

Front centre - Gas - AUX - 1.00 kW

Rear centre - Gas - Rapid - 3.00 kW

Front right - Gas - AUX - 1.00 kW

Rear right - Gas - Semi Rapid - 1.90 kW

Rear left - Gas - UR - 4.00 kW

Right - BBQ

Type of gas burners Standard

Burner caps Matt black enamelled

Automatic electronic ignition Yes

Automatic switch off when overflow Yes

Main Oven Technical Features



No. of lights	1
Fan number	1
Net volume of the cavity	61 l
Gross volume, 1st cavity	70 l
Cavity material	Ever Clean enamel
No. of shelves	4
Type of shelves	Metal racks
Light type	Halogen
Light Power	40 W
Cooking time setting	Contaminuti + fine cottura
Light when oven door is open	Yes
Door opening	Flap down
Removable door	Yes

Total no. of door glasses	3
No. of thermo-reflective door glasses	2
Safety Thermostat	Yes
Cooling system	Tangential
Usable cavity space dimensions (HxWxD)	316x460x412 mm
Temperature control	Electro-mechanical
Lower heating element power	1200 W
Upper heating element - Power	1000 W
Grill element	1700 W
Large grill - Power	2700 W

Full glass inner door Yes

Circular heating element 2000 W
- Power

Grill type Electric

Tilting grill Yes

Options Main Oven

Timer Yes

End of cooking acoustic alarm Yes

Minimum Temperature 50 °C

Maximum temperature 250 °C

Second Oven Technical Features



Net volume of the second cavity 55 l

Gross volume, 2nd cavity 70 l

Cavity material Ever Clean enamel

No. of shelves 4

Type of shelves Metal racks

No. of lights 1

Light type Halogen

Light Power 40 W

Cooking time setting Minute minder

Light when oven door is open Yes

Door opening Flap down

Removable door Yes

Full glass inner door Yes

No. total door glasses 3

No. thermo-reflective door glasses 2

Safety Thermostat Yes

Cooling system Tangential

Usable cavity space dimensions (HxWxD) 290x444x425 mm

Temperature control Electro-mechanical

Lower heating element - power 1100 W

Upper heating element - Power 1000 W

Grill element - power 1700 W

Large grill - Power 2700 W

Grill type Electric

Tilting grill Yes

Options Auxiliary Oven

Timer Yes

End of cooking acoustic alarm Yes

Minimum Temperature 50 °C

Maximum temperature 300 °C

Accessories included for Main Oven & Hob



Rack with back and side stop 1

20mm deep tray 1

40mm deep tray 1

Grill mesh 1

Catalytic panels 3

Telescopic Guide rails, total Extraction 1

Pizza Accessories Refractory stone + cover + shovel

Accessories included for Secondary Oven

Rack with back and side stop 1
 40mm deep tray 1

Grill mesh 1
 Catalitic panels 3

Electrical Connection

Plug Not present
 Electrical connection rating 7500 W
 Current 33 A
 Voltage 220-240 V
 Voltage 2 (V) 380-415 V

Electric cable Installed - Double and Three-phase
 Power supply cable length 150 cm
 Frequency 50/60 Hz
 Terminal block 5 poles

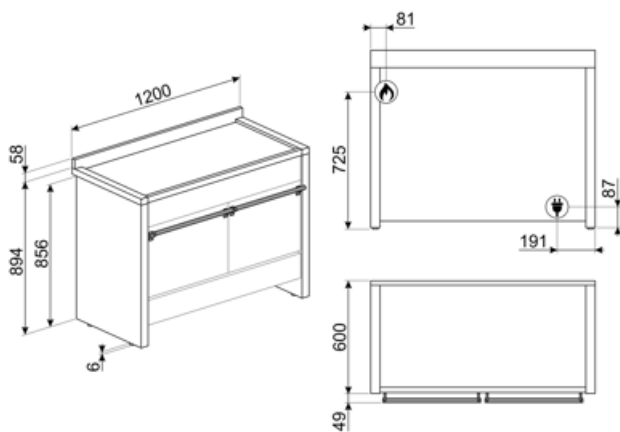

Not included accessories

AIRFRY

Air fryer rack AIRFRY . Ideal for recreating traditional frying in the oven, but with fewer calories and less fat. It allows you to cook quickly and simply dishes such as French fries, fried vegetables and fish, ensuring perfect browning and crispiness.



BN620-1

Enamelled tray suitable for 45cm and 60cm ovens. Depth 20 mm. Perfect for a wide range of savoury and sweet baking.



BNP608T

Teflon-coated tray, 8mm depth, to be placed on the grid



GRM

Coffee machine support



GTT

Totally extractable telescopic guides (1 level), suitable for traditional ovens. Made in stainless steel, they guarantee stability and facilitate the smooth extraction of the trays.



KIT2A3-2

Plinth, 120 cm, only frontal, stainless steel suitable for A3 and A4 Opera cookers



PALPZ

Pizza shovel with folding handle. Dimensions L31.5 x H32.5 cm. Easy and convenient to use and store. Perfect for serving pizza, bread and savory pastries in a safe and professional way.



BBQ

Double sided plate BBQ. Suitable for recreating succulent and crispy dishes in the oven with the typical taste of grilled cooking. The ribbed side is particularly suitable for meats and cheeses. The smooth side for fish, seafood and vegetables.



BN640

Enamelled tray suitable for 45cm and 60cm ovens. Depth 540 mm. Perfect for cooking and roasting meat and fish in sauces. Also ideal for experimenting with lighter and crunchy side dishes

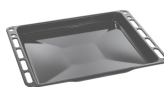

GC120

Cast iron grill plate suitable for A3/A4/A5 cookers



GTP

Partially extractable telescopic guides (1 level), suitable for traditional ovens. Made in stainless steel, they guarantee stability and facilitate the smooth extraction of the trays.



KIT1A3-8

Splashback, stainless steel, 120cm, suitable for Opera A3 cookers



KIT3-6

Height extension kit 2 lateral sides (950mm), stainless steel, for Opera cookers A2,A3,A4 (945-965mm)



SFLK1

Child lock



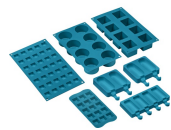

SMOLD

















Set of 7 silicone moulds for ice creams, ice lollies, pralines, ice cubes or to portion food. Usable from -60°C to +230°C

















TPKX

Stainless steel Teppanyaki plate, suitable for A1-9 Opera cooker

Symbols glossary

 <p>Heavy duty cast iron pan stands: for maximum stability and strength.</p>	 <p>Catalytic cleaning: the system ensures perfect hygiene inside the oven thanks to the three self-cleaning panels coated with a special enamel that promotes the progressive elimination of traces of grease and odors caused by cooking.</p>
	 <p>Installation in column: Installation in column</p>
 <p>Knobs control</p>	 <p>Air cooling system: to ensure a safe surface temperatures.</p>
 <p>4.3 inch display with LED technology, usability with knobs + 3 touch keys</p>	 <p>Triple glazed doors: Number of glazed doors.</p>
 <p>Ever Clean Enamel: Ever Clean enamel is applied electrostatically, corner to corner and edge to edge to prevent cracking or cracks over time. It is a particular pyrolytic enamel, resistant to acids which, in addition to being pleasantly bright, promotes greater cleaning of the oven walls, thanks to its lower porosity. It is baked at over 850 ° C and slowly polymerized at a scientifically determined rate to ensure uniform depth and strength Ever Clean enamel creates an impeccable finish both on the inside of the oven and on the trays, making the surfaces of the oven incredibly easy to maintain over time as it reduces the adhesion of fat during cooking</p>	 <p>Fingerprint proof stainless steel: Fingerprint proof stainless steel keeps stainless steel looking as good as new.</p>
 <p>Fan assisted base: the mix of fan and lower heating element alone allows to finish cooking foods already cooked on the surface but not internally more quickly. This system is recommended to finish cooking foods that are already well cooked on the surface, but not internally, which therefore require a moderate higher heat. Ideal for any type of food.</p>	 <p>Fan assisted: Intense and homogeneous traditional cooking, also suitable for complex recipes. The fan is active and the heat comes from below and from above at the same time. Ventilated cooking ensures a faster and more homogeneous result, leaving fragrant foods outside and moister inside. Ideal for baked pasta, biscuits, roasts and cobblers.</p>
 <p>Static: Traditional cooking suitable for the preparation of one dish at a time. The fan is not active and the heat comes from below and from above at the same time. Static cooking is slower and more delicate, ideal in order to get well cooked and dry dishes even inside. Ideal for cooking all types of roasts, fatty meats, bread, filled cakes.</p>	 <p>Circulaire: it is the perfect function for cooking all types of dishes in a more delicate way. The heat comes from the back of the oven and is distributed quickly and evenly The fan is active. It is also ideal for cooking on multiple levels without mixing smells and flavors.</p>
 <p>ECO: low energy consumption cooking: this function is particularly suitable for cooking on a single shelf with low energy consumption. It is recommended for all types of food except those that can generate a lot of moisture (for example vegetables). To achieve maximum energy savings and reduce time, it is recommended to put the food in the oven without preheating the cooking compartment</p>	 <p>Grill: Very intense heat coming only from above from a double heating element. The fan is not active. Provides excellent grilling and gratinating results. Used at the end of cooking, it gives a uniform browning to dishes.</p>

-  **Half grill:** For rapid cooking and browning of foods. Best results can be obtained by using the top shelf for small items, the lower shelves for larger ones, such as chops or sausages. For half grill heat is generated only at the centre of the element, so is ideal for smaller quantities.
-  **Pizza function:** Specific function for cooking pizza in a pan. It allows to obtain a pizza that is soft inside and crispy outside with the topping perfectly cooked, not dry and not burnt.
-  **Side lights:** Two opposing side lights increase visibility inside the oven.
-  **Overfill protection:** The special overfill protection shuts down the stove in the presence of overflow of liquids.
-  **Telescopic rails:** allow you to pull out the dish and check it without having to remove it from the oven entirely.
-  **Tilting grill:** the tilting grill can be easily unhooked to move the heating element and clean the roof of the appliance in one simple step.
-  **Vapor Clean:** a simple cleaning function using steam to loosen deposits in the oven cavity.
-  **The capacity indicates the amount of usable space in the oven cavity in litres.**
-  **Fan grill:** very intense heat coming only from above from a double heating element The fan is active. It allows the optimal grilling of thickest meats. Ideal for large cuts of meat.
-  **All glass inner door:** All glass inner door, a single flat surface which is simple to keep clean.
-  **Automatic opening:** some models have Automatic opening door when the cycle is finished which is a perfect solution for handle-less kitchen units as no handle is needed. For safety reasons, the door locks automatically when the machine is in use to avoid it being opened inadvertently.
-  **The oven cavity has 4 different cooking levels.**
-  **Electronic control:** Allows you to maintain temperature inside the oven with the precision 2-3 ° C. This enables to cook meals that are very sensitive to temperature changes, such as cakes, souffles, puddings.
-  **Ultra rapid burners:** Powerful ultra rapid burners offer up to 5kw of power.
-  **The capacity indicates the amount of usable space in the oven cavity in litres.**

Benefit (TT)

Gas hob

Gas provides permanent control of the heat source and the temperature change is immediate

Equipped with a thermocouple, the gas supply is cut off if the flame is extinguished for greater safety.

Catalysis

Easy oven cleaning through the use of catalytic panels in the cavity

This permanent process allows continuous cleaning and degreasing of the three cavity walls, starting its grease oxidation phase when the oven reaches 200°C.

Touch control

Easy and intuitive timer setting with a single touch

Drawer storage compartment

More space thanks to the lower drawer compartment, ideal for storing accessories or cooking utensils

True-convection

The best cooking performances guaranteed by ventilated circular flow

Multiple fans and heating elements guarantee the perfect aerodynamic heat flow, allowing homogeneous and quicker cooking inside the cavity.

Multilevel cooking

Several cooking levels allow maximum flexibility of use

Multilevel halogen light

Internal halogen lighting on different levels guarantees excellent visibility

Tangential cooling

New cooling system with tangential fan and airflow from the door to the splashback

Telescopic guides

Easy extraction and safe insertion of trays into the oven thanks to telescopic guides

Pizza stone (optional accessory)

Baking with refractory stone for soft and crispy pizza and yeast products (STONE optional accessory)

BBQ (optional accessory)

Barbeque cooking directly in the oven with the double-sided grill (BBQ optional accessory)

Isothermic Cavity

The best cooking performance at the highest energy efficiency

AirFry (AIRFRY optional accessory)

Lighter and tastier food thanks to airfry basket (optional accessory)

Cold door

During any function, the external door glass is cold, avoiding any risk of burns

Adjustable height

Cooker top flushed with the working area thanks to adjustable feet

Single turbine

The oven has a fan equipped with a circular heating element allowing cooking with rotating heat