

C7176DNPHSG



Product Family	Refrigerator
Installation	Built-in
Category	Bottom Mount
Built-in niche	178
Reference width	Until 60
Reference height	160 - 200
Cooling type	Fan assisted refrigerator, no-frost freezer
Defrost	Automatic
Hinge type	Door on door
Hinge position	Right
Reversible door	Yes
EAN code	8017709256166



Aesthetics



Aesthetic	Universale	Door shelves profile color	Silver
Colour	White	Drawers profile color	Silver
Side material	Steel	Color of glass shelf profile	Chrome
Side colour	White	Display	LCD Touch
Logo	Silk screen	Display position	

Refrigerator compartment features



No. of adjustable shelves	3	Type of crisper/vegetable drawers cover	Glass
Number of fruit and vegetables drawers	2	Low temperature compartment	Yes
Type of adjustable shelves	Glass	Internal light in fridge	Yes
Type of crisper/vegetable drawers cover	Standard	Type of internal light (fridge)	LED
Crisper Cover	Yes		

Refrigerator Inner Door

No. of door shelves with transparent cover	1	No. of bottle shelves	1
--------------------------------------------	---	-----------------------	---

Number of adjustable door shelves 2

Other Refrigerator features



Accessories Egg tray Fan Yes

Freezer compartment features

Number of drawers 3

Other Freezer features

Accessories 1 ice box, 2 eutectics

Other technical features



Functions display	Holiday, Fast freezing, Fast cooling, Control lock, Temperature alarm
Water network connection	
Temperature alarm lamp	Yes
Door open alarm	Yes
Temperature Alarm	Yes
Type of temperature control	Electronic
No. of compressors	1
Refrigerant gas type	R600a
Type of compressor	Standard
Refrigerant Quantity (gr)	45 g
Max weight door panel (fridge)	20 kg
Foam agent	Cyclopentane
Max weight door panel (freezer)	41 kg

Performance / Energy Label - Reg. 2019







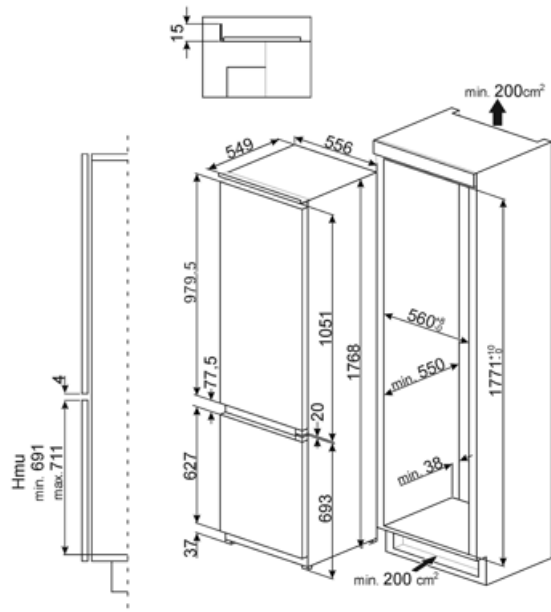



Airborne acoustical noise emissions 39 dB(A) re 1 pW

Electrical Connection

Plug	(G) UK e Singapore	Voltage (V)	230-240 V
Electrical connection rating	140 W	Frequency (Hz)	50 Hz
Current	1,1 A	Power supply cable length	240 cm



Symbols glossary

	4 stars freezing compartment for better food preservation.		The automatic defrost system works by automatically defrosting at regular intervals eliminating the need to defrost altogether.
	Child lock: some models are fitted with a device to lock the programme/cycle so it cannot be accidentally changed.		LCD display: to optimize performance and simplify the use of the appliance.
	Ventilated: Forced distribution of cold air in the refrigerator compartment, which allows even temperature distribution within the fridge.		Fast freezing: The fast freezing function brings the temperature of the compartment down when activated a few hours prior to usage.
	Power saving mode: The power saving mode allows you to disable the refrigerator and keep the freezer working.		LED interior lighting: is a more energy efficient and long lasting way of illuminating the interior of the appliance.
	Built-in niche		No Frost: The No Frost and Frost free systems prevent ice from forming so that no defrosting is required.