

C875TNE



Product Family	Refrigerator
Installation	Built-in
Category	Bottom Mount
Built-in niche	200
Reference width	70 - 80
Reference height	160 - 200
No-Frost system	Yes
Cooling type	No frost
Defrost	Automatic
Hinge type	Sliding
Hinge position	Right
Reversible door	Yes
EAN code	8017709321178



Aesthetics

Aesthetics	Universal	Door shelves profile colour	Chrome
Colour	White	Drawers profile colour	Chrome
Material	Metal sheet	Colour of glass shelf profile	Chrome
Side material	Steel	Display	7 segments
Side colour	White	Display position	Interior (on the top)

Refrigerator compartment features



No. of adjustable shelves	3	Bottle shelf	Yes
Number of fruit and vegetables drawers	1	Type of crisper/vegetable drawers cover	Glass
Type of adjustable shelves	Glass	Life Plus zone-0°C	Yes
Type of crisper/vegetable drawers cover	Standard	Internal light in fridge	Yes
Crisper Cover	Yes	Type of internal light (fridge)	LED

Refrigerator Inner Door

Number of adjustable door shelves	5	Bottle shelves with wire support	Yes
No. of bottle shelves	1		

Other Refrigerator features



Accessories	Egg tray	Fan	Yes
Natural Plus Blu Light	Yes	Antibacterial odour filter	Yes
MultiFlow	Yes		

Freezer compartment features

Number of drawers	3	No. of shelves	2
-------------------	---	----------------	---

Other Freezer features



Accessories	1 ice box	Ice tray shelf	Yes
Fast freezing compartment	Yes		

Other technical features



Functions display	Holiday, Fast freezing, Fast cooling, Temperature alarm
Door open alarm	Yes
Temperature Alarm	Yes
Type of temperature control	Electronic
No. of compressors	1
Refrigerant gas type	R600a
Type of compressor	Variable Speed Compressor
Foam agent	Cyclopentane

Performance / Energy Label



Annual energy consumption	247 KWh/year	Noise level	35 dB(A) re 1 pW
Energy efficiency class	E	Thaw time	9 h
Airborne acoustical noise emission class	B	4 star - Freezing capacity	5.2 Kg/24h
Total volume	370 l	Climatic class	SN, T
Sum of the volumes of the frozen compartment(s)	90 l	EEl	100 %







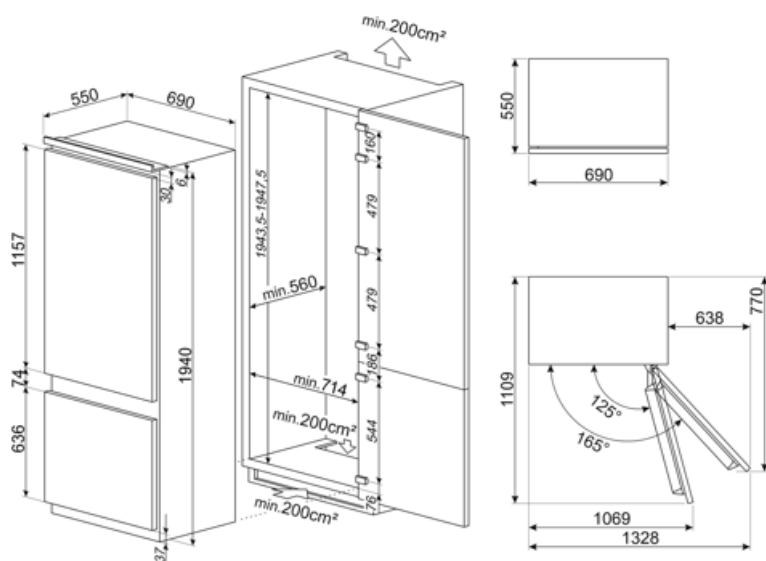



Sum of the volumes of the chill compartment(s) and the unfrozen compartment(s) 280 l

Electrical Connection

Plug	(F;E) Schuko	Voltage (V)	220-240 V
Nominal power	95 W	Frequency (Hz)	50 Hz
Current	0.8 A	Power supply cable length	193 cm



Symbols glossary

-  The automatic defrost system works by automatically defrosting at regular intervals eliminating the need to defrost altogether.
-  Ventilated: Forced distribution of cold air in the refrigerator compartment, which allows even temperature distribution within the fridge.
-  Power saving mode: The power saving mode allows you to disable the refrigerator and keep the freezer working.
-  Life Plus 0°C: The temperature in the Lifeplus compartments is kept at 0°C, which preserves fresh meat and fish longer.
-  Air plus: keeps food fresher for longer.
-  Built-in niche
-  Energy efficiency class E
-  Fast freezing: The fast freezing function brings the temperature of the compartment down when activated a few hours prior to usage.
-  LED interior lighting: is a more energy efficient and long lasting way of illuminating the interior of the appliance.
-  Inverter technology: The evolution of Smeg's driers towards more intelligent and environmentally sustainable models has led to the choice of using Inverter technology with heat pumps, which reduces significantly energy consumption.
-  Natural Plus Blu Light: This unique Natural Plus Blu Light system works with nature to increase the storage time of fruit and vegetables.