

C92IMMB2

Categorie fornuis	90x60 cm
Aantal ovens met energielabel	2
Cavity heat source	Elektrisch
Type kookplaat	Inductie
Type primaire oven	Thermogeventileerd
Type secundaire oven	Statisch
Reinigingssysteem primaire oven	Vapor Clean
EAN-code	8017709331047
Energie-efficiëntieklasse	A
Energie-efficiëntieklasse, tweede oven	A



Design



Esthetiek	Classici	Bedieningsknoppen	Smeg Classici
Series	Sinfonia	Kleur knoppen	Roestvrij staal
Design	Squadrato	Aantal bedieningsknoppen	8
Kleur	Matt Black	Kleur serigrafie	Zilver
Afwerking	Mat	Display	DigiScreen
Afwerking bedieningspaneel	Gekleurd plaatstaal	Deur	Met 2 horizontale stroken
Logo	Assembled st/steel	Type glas	Eclipse zwart glas
Positie logo	Strook onder de oven	Handgreep	Smeg Classici
Kleur kookplaat	Roestvrij staal	Kleur handgreep	Geborsteld roestvrijstaal
Type bediening	Bedieningsknoppen	Opbergruimte	Klep
Slider	Rood	Pootjes	Zilver

Programma's / functies

Aantal kookfuncties 8

Traditionele kookfuncties



Statisch

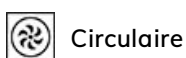

Circulaire



Turbo



ECO

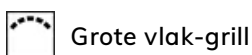

Grote vlak-grill

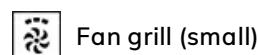

Fan grill (small)

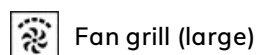

Fan grill (large)

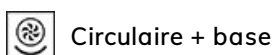

Circulaire + base

Overige functies

 Ontdooien op tijd

Schoonmaak functie

 Vapor Clean

Programma's / functies secundaire oven

Kookfuncties ovenruimte 2 3

Traditionele kookfuncties, ovenruimte 2

 Statisch

 Grote vlak-grill

 Bodem

Technische specificaties kookplaat



Totaal aantal kookzones 5

Linksvoor - Inductie - Multizone - 2.10 kW - Booster 2.30 kW - 21.0x19.0 cm

Linksachter - Inductie - Multizone - 1.60 kW - Booster 1.85 kW - 21.0x19.0 cm

Midden - Inductie - enkel - 2.30 kW - Booster 3.00 kW - Ø 27.0 cm

Rechtsachter - Inductie - enkel - 1.20 kW - Booster 1.40 kW - Ø 18.0 cm

Rechtsvoor - Inductie - enkel - 2.30 kW - Booster 3.00 kW - Ø 21.0 cm

Number of Flexible zones	1	Indicator minimaal te gebruiken diameter	Ja
Automatische stop bij oververhitting	Ja	Indicator geselecteerde zone	Ja
Automatisch uitschakelen i.g.v. overkoken	Ja	Restwarmte indicator	Ja
Automatische aanpassing panafmeting	Ja		

Technische specificaties primaire oven



Aantal lampen	1	Uitneembaar glas binnendeur	Ja
Aantal ventilatoren	1	Aantal ruiten ovendeur	3
Netto inhoud	70 l	Aantal thermo-reflecterende ruiten	2
Bruto inhoud 1e oven	79 l	Veiligheidsthermostaat	Ja
Materiaal ovenruimte	Ever Clean emaille	Koelsysteem	Mantelkoeling
Aantal kookniveaus	5	Afmetingen bruikbare interne ovenruimte (hxbxd)	360X460X425 mm
Type ovenrekken	Metalen zijsteunen	Temperatuurregeling	Elektro-mechanisch
Soort verlichting	Halogeen		
Vermogen lamp	40 W		
Instelling kooktijd	Start en stop		

Automatische inschakeling verlichting bij openen deur	Ja	Onderwarmte - vermogen	1200 W
Deur openen	naar beneden	Bovenwarmte - vermogen	1000 W
Uitneembare ovendeur	Ja	Grill - vermogen	1700 W
Volledig glazen binnendeur	Ja	Grote vlakgrill - vermogen	2700 W
		Circulatie - vermogen	2000 W
		Type grill	Elektrisch

Opties primaire oven

Timer	Ja	Minimum temperatuur	50 °C
Akoestisch signaal einde kooktijd	Ja	Maximum temperatuur	260 °C

Technische specificaties secundaire oven



Netto inhoud (l) oven 2	35 l	Aantal ruiten ovendeur	3
Bruto inhoud, 2e oven	36 l	Aantal thermo-reflecterende ruiten	2
Materiaal ovenruimte	Ever Clean emaille	Veiligheidsthermostaat	Ja
Aantal kookniveaus	4	Koelsysteem	Mantelkoeling
Type ovenrekken	Metalen zijsteunen	Afmetingen bruikbare interne ovenruimte (hxbxd)	311x206x418 mm
Aantal lampen	1	Temperatuurregeling	Elektro-mechanisch
Soort verlichting	Gloeilamp	Onderwarmte - vermogen	700 W
Vermogen lamp	25 W	Bovenwarmte - vermogen	600 W
Deur openen	naar beneden	Grill - vermogen	1300 W
Uitneembare ovendeur	Ja	Grote vlakgrill - vermogen	1900 W
Volledig glazen binnendeur	Ja	Type grill	Elektrisch
Uitneembaar glas binnendeur	Ja		

Opties secundaire oven

Minimum temperatuur	50 °C	Maximum temperatuur	245 °C
---------------------	-------	---------------------	--------

Meegeleverde accessoires primaire oven en kookplaat



Rek met achter- en zijstop	2	Inzetrooster	1
Bakplaat (40 mm)	1	Telescopische geleiders, gedeeltelijk uitschuifbaar	1

Meegeleverde accessoires secundaire oven

Rek met achter- en zijstop	1	Inzetrooster	1
Bakplaat	1		

Elektrische aansluiting

Aansluitwaarde	11000 W	Electric cable	Installed, Single phase
Stroom	33 A	Type stroomkabel	Double and Three Phase
Spanning	220-240 V	Frequentie	50/60 Hz
Spanning 2 (V)	380-415 V	Aansluitkast	5 polig

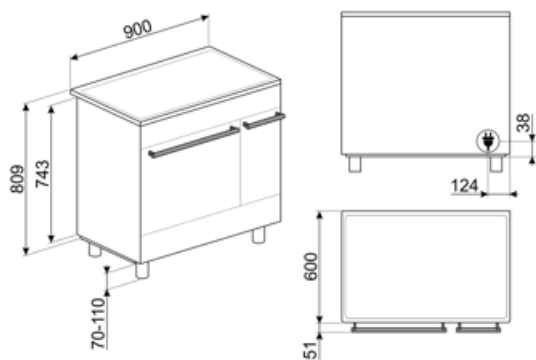

Accessoires niet inbegrepen

BBQ

Dubbelzijdig



BN640

Geëmailleerde bakplaat, 40 mm diep

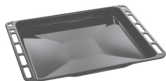

GRILLPLATE

Universal griddle for induction, gas, ceramic and electric hobs. Non-stick surface ideal for cooking meat, cheese and vegetables. Dimensions: 410 x 240 mm.



GTT

Volledig uittrekbare telescopische geleiders (1 niveau)



KITH900CPF9

Plinth, 90cm, three sides, black, suitable for CPF9 Portofino or Sinfony C9 cookers



KITPBX

Height reduction feet (850mm), st/steel, for Sinfonia and Master cookers (845-856mm)



SCRP

Inductie- en keramische kookplaten en teppanyaki-schraper



SMOLD

Set van 7 siliconen vormpjes voor ijsjes, ijslolly's, pralines, ijsblokjes of om etenswaren te portioneren. Bruikbaar van -60 ° C tot + 230 ° C

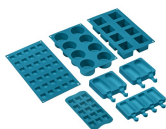

BN620-1

Geëmailleerde bakplaat, 20 mm diep



BNP608T

Teflon-coated tray, 8mm depth, to be placed on the grid



GTP

Gedeeltelijk uittrekbare telescopische geleiders (1 niveau)



KITC9X9-1

Spatscherm, 90x75 cm, RVS, geschikt voor Portofino, Master en Sinfonia fornuizen

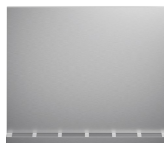

KITH95CPF9

Height extension kit with plinth, (950mm), three sides, black with feet, suitable for CPF9 Portofino and Sinfony C9 cookers



PALPZ

Pizzaschep met inklapbare handgreep breedte: 315 mm lengte: 325 mm



SFLK1

Kinderslot



STONE

Rectangular refractory stone Ideal for cooking pizzas with the same results as a typical wood-fired oven. Can also be used for baking bread, focaccias and other recipes such as pies, flans or biscuits Dimensions:L42 x H1,8 x P37,5 cm.





































TPKPLATE



Universal plate for induction, gas, ceramic and electric hobs. Non-stick surface ideal for cooking fish, eggs and vegetables. Dimensions: 410 X 240 mm.

Symbols glossary

 <p>Automatic merge of zones for a bigger area</p>	 <p>A: Droogprestaties van het product, gemeten vanaf A +++ tot D / G afhankelijk van de productfamilie</p>
 <p>Installation in column: Installation in column</p>	 <p>Knobs control</p>
 <p>Luchtkoelsysteem: om een veilig oppervlak te garanderen temperaturen.</p>	 <p>Ontdooien op tijd: met deze functie wordt automatisch het tijdstip van ontdooien van voedsel bepaald</p>
 <p>4.3 inch display with LED technology, usability with knobs + 3 touch keys</p>	 <p>Deuren met driedubbele beglazing: aantal glazen deuren.</p>
 <p>ECO-logic: optie stelt u in staat om de vermogenslimiet van de werkelijke energiebesparing van het apparaat te beperken</p>	 <p>Geëmailleerde binnenkant: De geëmailleerde binnenkant van alle Smeg-ovens heeft een speciale antacidumvoering die helpt om de binnenkant schoon te houden door de hoeveelheid kookvet te verminderen.</p>
 <p>De ovenruimte wordt tegelijk door het onder- en bovinelement verwarmt. De hitteverdeling over het gerecht is afhankelijk van het niveau waarop men dit plaatst. Geschikt voor bakken op 1 niveau. Gerechten: alle ovenschotels, vlees, gevogelte, brood, (gevulde) taarten. Speciaal: gans en eend (bevatten veel vet).</p>	 <p>De ovenruimte wordt uitsluitend verhit door het onderelement. Voor gerechten die een hoge basistemperatuur behoeven, heeft deze bakstand weinig tot geen invloed op de korst aan de bovenzijde. Geschikt voor bakken op 1 niveau, ideaal voor deeggerechten die moeten rijzen (bijv. pizza). Bij gevulde taarten zal de deegbodem beter droog blijven.</p>
 <p>Circulaire with lower element: The addition of the lower element adds extra heat at the base for food which requires extra cooking.</p>	 <p>Circulaire: it is the perfect function for cooking all types of dishes in a more delicate way. The heat comes from the back of the oven and is distributed quickly and evenly The fan is active. It is also ideal for cooking on multiple levels without mixing smells and flavors.</p>
 <p>ECO: low energy consumption cooking: this function is particularly suitable for cooking on a single shelf with low energy consumption. It is recommended for all types of food except those that can generate a lot of moisture (for example vegetables). To achieve maximum energy savings and reduce time, it is recommended to put the food in the oven without preheating the cooking compartment</p>	 <p>Ventilator met grillelement: De ventilator vermindert de felle hitte van de grill en biedt een uitstekende methode om verschillende soorten voedsel, karbonades, steaks, worstjes enz. Te grillen, waardoor het gelijkmatig bruin wordt en de warmte wordt verdeeld, zonder het voedsel uit te drogen. De bovenste twee niveaus die voor gebruik worden aanbevolen, en het onderste deel van de oven kunnen worden gebruikt om gerechten tegelijkertijd warm te houden, een uitstekende mogelijkheid bij het bereiden van een gegrild ontbijt. Halve grill (alleen middengedeelte) is ideaal voor kleine hoeveelheden voedsel.</p>

-  De warmte wordt geproduceerd door het grill- en bovenelement. Verhitting over het volledige oppervlak. De thermostaat wordt, afhankelijk van het gerecht, in de regel op de maximale stand gezet. Bij een korte baktijd kan de oven gesloten blijven; bij langere baktijd blijft deze gedeeltelijk geopend. Voor vleesgerechten (klein- en middelgroot), vleespennen, vis, groenten, gratineren etc.
-  Light
-  Overheat protection: The safety system that automatically turns off the hob in case of overheating of the control unit.
-  All glass inner door: All glass inner door, a single flat surface which is simple to keep clean.
-  verlichting
-  Overfill protection: The special overfill protection shuts down the stove in the presence of overflow of liquids.
-  The oven cavity has 4 different cooking levels.
-  Telescopic rails: allow you to pull out the dish and check it without having to remove it from the oven entirely.
-  Vapor Clean: a simple cleaning function using steam to loosen deposits in the oven cavity.
-  The capacity indicates the amount of usable space in the oven cavity in litres.
-  Ventilator met grillelement: De ventilator vermindert de felle hitte van de grill en biedt een uitstekende methode om verschillende soorten voedsel, karbonades, steaks, worstjes enz. Te grillen, waardoor het gelijkmatig bruin wordt en de warmte wordt verdeeld, zonder het voedsel uit te drogen. De bovenste twee niveaus die voor gebruik worden aanbevolen, en het onderste deel van de oven kunnen worden gebruikt om gerechten tegelijkertijd warm te houden, een uitstekende mogelijkheid bij het bereiden van een gegrild ontbijt. Halve grill (alleen middengedeelte) is ideaal voor kleine hoeveelheden voedsel.
-  Turbo: the heat comes from 3 directions: above, below and from the back of the oven The fan is active. It allows quick cooking, even on several shelves without mixing the aromas. Ideal for large volumes or foods that require intense cooking.
-  Induction: The work of these hobs is based on the principle of electromagnetic induction. The heat is generated directly in the bottom of the pan during its contact with the hob.
-  The inner door glass: can be removed with a few quick movements for cleaning.
-  Automatic opening: some models have Automatic opening door when the cycle is finished which is a perfect solution for handle-less kitchen units as no handle is needed. For safety reasons, the door locks automatically when the machine is in use to avoid it being opened inadvertently.
-  Indication of residual heat: After the glass ceramic hob is switched off the residual heat indicator shows which of the heating zones still remains hot. When the temperature drops below 60 ° C, the indicator goes out.
-  The oven cavity has 5 different cooking levels.
-  Electronic control: Allows you to maintain temperature inside the oven with the precision 2-3 ° C. This enables to cook meals that are very sensitive to temperature changes, such as cakes, souffles, puddings.
-  The capacity indicates the amount of usable space in the oven cavity in litres.

Benefit (TT)

Induction hob

Induction offers fast cooking and precise temperature control

Through the use of suitable cookware, induction is easy to use and maintain, safe and responsive.

Vapor Clean

By inserting water into a recess at the bottom of the cavity, steam is generated, which softens the residue and facilitates its removal

By inserting water into a recess at the bottom of the cavity, steam is generated, which softens the residue and facilitates its removal.

Touch control

Easy and intuitive timer setting with a single touch

Storage compartment

More space thanks to the lower compartment, ideal for storing accessories or cooking utensils

True-convection

The best cooking performances guaranteed by ventilated circular flow

Multiple fans and heating elements guarantee the perfect aerodynamic heat flow, allowing homogeneous and quicker cooking inside the cavity.

Multilevel cooking

Several cooking levels allow maximum flexibility of use

Multilevel halogen light

Internal halogen lighting on different levels guarantees excellent visibility

Removable inner glass

Internal door glasses are easily removable for complete cleaning

Tangential cooling

New cooling system with tangential fan and airflow from the door to the splashback

Telescopic guides

Easy extraction and safe insertion of trays into the oven thanks to telescopic guides

Isothermic Cavity

The best cooking performance at the highest energy efficiency

Adjustable height

Cooker top flushed with the working area thanks to adjustable feet

AirFry (AIRFRY optional accessory)

Lighter and tastier food thanks to airfry basket (optional accessory)

Cold door

During any function, the external door glass is cold, avoiding any risk of burns

Pizza stone (optional accessory)

Baking with refractory stone for soft and crispy pizza and yeast products (STONE optional accessory)

BBQ (optional accessory)

Barbeque cooking directly in the oven with the double-sided grill (BBQ optional accessory)

Single turbine

The oven has a fan equipped with a circular heating element allowing cooking with rotating heat