

# CB300U



<b>Product family</b>	Refrigerator
<b>Installation</b>	Built-in
<b>Category</b>	Bottom mount
<b>No-frost system</b>	Total
<b>Cooling type</b>	Fan-assisted refrigerator, no-frost freezer
<b>Defrost</b>	Automatic
<b>Hinge</b>	Door-to-door
<b>Hinge position</b>	Right
<b>Reversible door</b>	Yes
<b>EAN code</b>	8017709200336



## Aesthetic



<b>Finishing</b>	Panel-ready	<b>Glass shelf profile color</b>	White
<b>Material</b>	Steel	<b>Display</b>	LED
<b>Side material</b>	Steel	<b>Display position</b>	Internal
<b>Logo</b>	Silkscreened		

## Refrigerator compartment features



<b>No. of adjustable shelves</b>	3	<b>Crisper cover</b>	Yes
<b>Number of fruit and vegetables drawers</b>	2	<b>Refrigerator lighting</b>	Yes
<b>Type of adjustable shelves</b>	Glass	<b>Refrigerator lighting</b>	LED

## Refrigerator Inner Door

<b>No. of door shelves with transparent cover</b>	1	<b>No. of bottle shelves</b>	1
<b>Number of adjustable door shelves</b>	1	<b>Door bin with wire support</b>	Yes

## Other Refrigerator features



Accessories  
Fan

Egg tray  
Yes

Anti-odour filter

Yes

## Freezer features

Number of drawers 3

## Other Freezer features



Accessories

1 x ice box

Fast-freezing  
compartment

Yes

## Other technical features



Display functions

Holiday, Fast-cooling, Child lock

Fast-freezing button

Yes

Water network connection

Power-on light

Yes

Temperature alarm

Yes

Door open alarm

Yes

Antibacterial gasket

Yes

Temperature setting type

Electro-mechanical

No. of compressors

1

Refrigerant gas type

R600a

Refrigerant quantity

1.8 oz

Foam agent

Cyclopentane

## Performance / Energy Label

Noise level 39 dB(A) re 1 pW

## Electrical Connection

Plug (A) USA & Mexico

Voltage (V)

120 V

Electrical connection  
rating

170 W







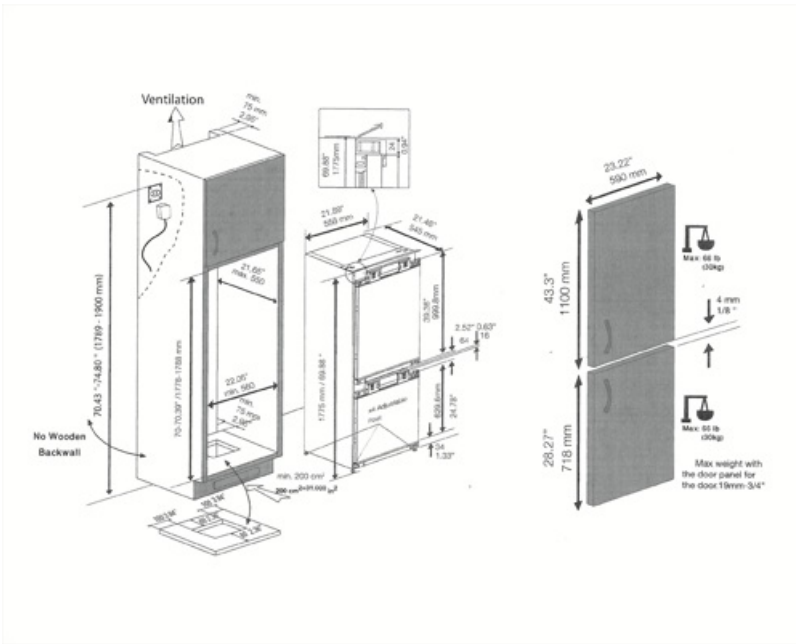



Frequency (Hz)

60 Hz

Current 2,1 A



## Symbols glossary

	4 stars freezing compartment for better food preservation.		The automatic defrost system works by automatically defrosting at regular intervals eliminating the need to defrost altogether.
	Antibacterial treatment: antibacterial treatment to ensure better hygiene		Child lock: some models are fitted with a device to lock the programme/cycle so it cannot be accidentally changed.
	LED display: to show programmes, functions and options selected and the time to the end of the cycle.		Ventilated: Forced distribution of cold air in the refrigerator compartment, which allows even temperature distribution within the fridge.
	Fast freezing: The fast freezing function brings the temperature of the compartment down when activated a few hours prior to usage.		Power saving mode: The power saving mode allows you to disable the refrigerator and keep the freezer working.
	LED interior lighting: is a more energy efficient and long lasting way of illuminating the interior of the appliance.		Built-in niche
	No Frost: The No Frost and Frost free systems prevent ice from forming so that no defrosting is required.		