

CPF36UGGR

Range size	36"
N. of cavities with energy label	1
Oven energy source	Gas
Main oven	Gas with grill
EAN code	8017709265229



Aesthetic



Aesthetics	Portofino	Controls color	Stainless steel
Design	Flush mounted	No. of controls	8
Color	Red	Silkscreen color	Black
Control panel finish	Metal enameled	Display	Touch
Logo	Stainless steel	Door	With frame
Logo position	Fascia below the oven	Door glass type	Gray
Upstand	Yes	Handle	Portofino
Cooktop color	Stainless steel	Handle color	Colored
Grates	Cast Iron	Storage compartment	Push-pull
Control setting type	Control knobs	Feet	Stainless steel
Control knobs	Portofino	Plinth	Black

Programs / Functions

No. of cooking functions 3

Traditional cooking functions



Large grill

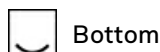

Bottom

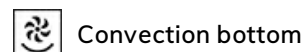

Convection bottom

Other functions



Defrost by time

Cooktop technical features

UR

Cooking zones 5

Left - Gas - Dual ultra-rapid - 5860 W - 20000 BTU
 Rear-center - Gas - AUX - 1310 W - 4500 BTU
 Front-center - Gas - Rapid - 3080 W - 10500 BTU
 Rear-right - Gas - Rapid - 3510 W - 12000 BTU
 Front-right - Gas - Semi-rapid - 2340 W - 8000 BTU

Burners type	Standard	Gas safety valves	Yes
Automatic gas ignition	Yes	Burner caps	Enameled matte black

Main Oven Technical Features



No. of lights	2	Full-glass inner door	Yes
Fan number	3	Removable inner door	Yes
Volume	0.16 cu. ft.	Total no. of door glasses	3
Cavity material	EverClean enamel	No. of thermo-reflective door glasses	2
No. of shelves	5	Safety thermostat	Yes
Shelves type	Metal racks	Cooling system	Tangential
Light type	Halogen	Inner cavity dimensions (HxWxD)	345 x 690 x 415 "
Light Power	40 W	Temperature control	Electro-mechanical
Time setting	Start and end	Grill type	Gas
Door opening	Drop-down	Soft Close system	Yes
Removable door	Yes		

Main oven options

Timer	Yes	Minimum Temperature	120 °F
End-of-cooking alarm	Yes	Maximum temperature	500 °F

Included accessories



Cast iron wok support	1	Grill mesh	1
TOP Oven grid with back stop	2	Telescopic Guide rails, total Extraction	1
0.8"-deep tray	1		

Electrical Connection

Plug	(B) NEMA 5-15P	Type of electric cable installed	Yes, Single phase
Electrical connection rating	200 W	Power cord length	47 1/4 "
Current	2 A	Frequency	60 Hz
Circuit breaker	15 A	Terminal block	3 pins
Voltage	120 V		

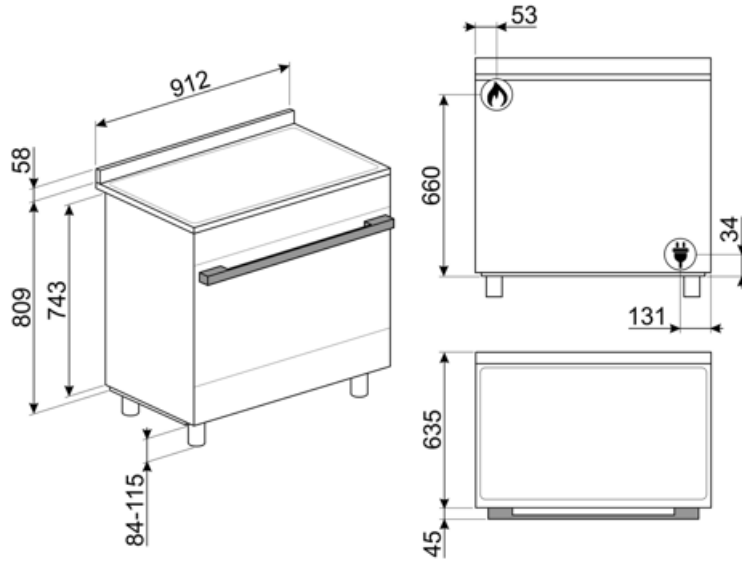

Not included accessories



BGTR9

Cast iron grill plate suitable for 90 cm Victoria, 60 and 90 cm Master and Sinfonia cookers



PALPZ

Pizza shovel with fold away handle
width: 315mm length : 325mm



SFLK1

Child lock























GT3T



PPR9

Refractory pizza stone without handles. Squared stone (HxWxD): 0.9" x 25.2" x 14.75". Also suitable for gas ovens, to be placed on a rack

Symbols glossary

 <p>Triple Fan Technology: The oven is equipped with an exclusive three fan system, which, combined with the increased power of the motors, enables excellent cooking performance. The two large side fans distribute the air around the outer perimeter of the cavity while the smaller central fan increases ventilation by creating a vertical vortex of heat. Accordingly, the temperature within the cavity is uniform, allowing food to be cooked evenly on all five levels, like in professional kitchens.</p>	 <p>Heavy duty cast iron pan stands: for maximum stability and strength.</p>
 <p>Installation in column: Installation in column</p>	 <p>Air cooling system: to ensure a safe surface temperatures.</p>
 <p>Defrost by time: with this function the time of thawing of foods are determined automatically.</p>	 <p>Triple glazed doors: Number of glazed doors.</p>
 <p>Enamel interior: The enamel interior of all Smeg ovens have a special antacid lining which helps keep the interior clean by reducing the amount of cooking grease adhering to it.</p>	 <p>Circogas: In gas ovens the fan distributes the heat quickly and evenly throughout the oven cavity, avoiding flavour transfer when cooking a number of different dishes at the same time. In electric ovens this combination completes cooking more quickly of foods that are ready on the surface, but that require more cooking inside, without further browning.</p>
 <p>Lower heating element only: This function is ideal for foods that require extra base temperature without browning, e.g. pastry dishes, pizza. Also suitable for slow cooking of stews and casseroles.</p>	 <p>Grill element: Using of grill gives excellent results when cooking meat of medium and small portions, especially when combined with a rotisserie (where possible). Also ideal for cooking sausages and bacon.</p>
 <p>Gas ovens offer instantaneous heat control, reduced cooking times and the ability to bake at much lower temperatures than electric ovens.</p>	 <p>All glass inner door: All glass inner door, a single flat surface which is simple to keep clean.</p>
 <p>The inner door glass: can be removed with a few quick movements for cleaning.</p>	 <p>Side lights: Two opposing side lights increase visibility inside the oven.</p>
 <p>Automatic opening: some models have Automatic opening door when the cycle is finished which is a perfect solution for handle-less kitchen units as no handle is needed. For safety reasons, the door locks automatically when the machine is in use to avoid it being opened inadvertently.</p>	 <p>The oven cavity has 5 different cooking levels.</p>
 <p>Soft close: all models are equipped with advanced function of smooth closing of the door, which allows the device to close smoothly and quietly.</p>	 <p>Telescopic rails: allow you to pull out the dish and check it without having to remove it from the oven entirely.</p>
 <p>Ultra rapid burners: Powerful ultra rapid burners offer up to 5kw of power.</p>	 <p>...</p>



Knobs control

Benefit (TT)

Gas hob

Gas provides permanent control of the heat source and the temperature change is immediate

Equipped with a thermocouple, the gas supply is cut off if the flame is extinguished for greater safety

Touch control

Easy and intuitive timer setting with a single touch

Push-pull storage compartment

More space thanks to the lower push-pull compartment, ideal for storing accessories or cooking utensils

Multilevel cooking

Several cooking levels allow maximum flexibility of use

Multilevel halogen light

Internal halogen lighting on different levels guarantees excellent visibility

Removable inner glass

Internal door glasses are easily removable for complete cleaning

Tangential cooling

New cooling system with tangential fan and airflow from the door to the splashback

Telescopic guides

Easy extraction and safe insertion of trays into the oven thanks to telescopic guides

Isothermic Cavity

The best cooking performance at the highest energy efficiency

BBQ (optional accessory)

Barbeque cooking directly in the oven with the double-sided grill

Pizza stone (optional accessory)

Baking with refractory stone for soft and crispy pizza and yeast products (STONE optional accessory)

Cold door

During any function, the external door glass is cold, avoiding any risk of burns

AirFry (AIRFRY optional accessory)

Lighter and tastier food thanks to airfry basket

Adjustable height

Cooker top flushed with the working area thanks to adjustable feet

Soft close

The door is equipped with a specific system for silent closing

Triple Turbine

The oven has three fans and two circular heating elements, allowing cooking with rotating heat