

# CPF9IPWH

Cooker size	90x60 cm
N. of cavities with energy label	1
Cavity heat source	Electric
Hob type	Induction
Type of main oven	Thermo-ventilated
Cleaning system main oven	Pyrolytic
EAN code	8017709240769
Energy efficiency class	A+



## Aesthetics



<b>Aesthetics</b>	Portofino	<b>No. of controls</b>	7
<b>Design</b>	Flush fit	<b>Serigraphy colour</b>	Black
<b>Colour</b>	White	<b>Display</b>	TFT
<b>Command panel finish</b>	Enamelled metal	<b>Door</b>	With frame
<b>Logo</b>	Assembled st/steel	<b>Glass type</b>	Grey
<b>Logo position</b>	Facia below the oven	<b>Handle</b>	Smeg Portofino
<b>Upstand</b>	Yes	<b>Handle Colour</b>	coloured
<b>Hob colour</b>	Stainless steel	<b>Storage compartment</b>	Push pull
<b>Type of control setting</b>	Control knobs	<b>Feet</b>	Black
<b>Control knobs</b>	Smeg Portofino	<b>Plinth</b>	Black
<b>Controls colour</b>	Stainless steel		

## Programs / Functions

No. of cooking functions	10
--------------------------	----

### Traditional cooking functions

- Static
- Fan assisted
- Circulaire
- Turbo (circulaire + bottom + upper + fan)
- ECO
- Small grill
- Large grill
- Fan grill (large)
- Base
- Fan assisted base

### Other functions

- Defrost by time
- Defrost by weight
- Proving
- Sabbath

### Cleaning functions

- Pyrolytic
- Pyrolytic eco

Automatic programs 20

## Hob technical features



**Total no. of cook zones** 5

Front left - Induction - single - 1.40 kW - Booster 2.20 kW - Ø 14.5 cm

Rear left - Induction - single - 1.85 kW - Booster 3.00 kW - Ø 18.0 cm

Central - Induction - single - 2.60 kW - Booster 3.70 kW - Ø 27.0 cm

Rear right - Induction - single - 2.30 kW - Booster 3.70 kW - Ø 21.0 cm

Front right - Induction - single - 1.40 kW - Booster 2.20 kW - Ø 14.5 cm

- |   |     |                                |     |
|---|-----|--------------------------------|-----|
| <b>Automatic switch off when overheat</b> | Yes | <b>Selected zone indicator</b> | Yes |
| <b>Automatic pan detection</b>            | Yes | <b>Residual heat indicator</b> | Yes |
| <b>Minimum pan diameter indication</b>    | Yes |                                |     |

## Main Oven Technical Features



- |                                 |                   |  |     |
|---------------------------------|-------------------|--|-----|
| <b>No. of lights</b>            | 2                 | <b>Total no. of door glasses</b>             | 4   |
| <b>Fan number</b>               | 3                 | <b>No. of thermo-reflective door glasses</b> | 3   |
| <b>Net volume of the cavity</b> | 115 litres        | <b>Safety Thermostat</b>                     | Yes |
| <b>Gross volume, 1st cavity</b> | 129 l             |  |     |
| <b>Cavity material</b>          | Easy clean enamel |  |     |

<b>Shelf positions</b>	5	<b>Heating suspended when door is opened</b>	Yes
<b>Type of shelves</b>	Metal racks	<b>Cooling system</b>	Tangential
<b>Light type</b>	Halogen	<b>Door Lock During Pyrolysis</b>	Yes
<b>Light power</b>	40 W	<b>Usable cavity space dimensions (HxWxD)</b>	371x724x418 mm
<b>Cooking time setting</b>	Start and Stop	<b>Temperature control</b>	Electronic
<b>Light when oven door is open</b>	Yes	<b>Lower heating element power</b>	1700 W
<b>Door opening</b>	Flap down	<b>Upper heating element - Power</b>	1200 W
<b>Removable door</b>	Yes	<b>Grill element</b>	1700 W
<b>Full glass inner door</b>	Yes	<b>Large grill - Power</b>	2900 W
<b>Removable inner door</b>	Yes	<b>Circular heating element - Power</b>	2 x 1850 W
		<b>Grill type</b>	Electric
		<b>Soft Close system</b>	Yes

## Options Main Oven

<b>Timer</b>	Yes	<b>Minimum Temperature</b>	50 °C
<b>End of cooking acoustic alarm</b>	Yes	<b>Maximum temperature</b>	260 °C

## Accessories included for Main Oven & Hob



<b>Chrome shelf with back and side stop</b>	1	<b>Grill mesh</b>	1
<b>20mm deep tray</b>	1	<b>Telescopic Guide rails, partial Extraction</b>	1
<b>40mm deep tray</b>	1		

## Electrical Connection

<b>Max Power Draw</b>	11400 W	<b>Type of electric cable</b>	Yes, Single phase
<b>Current</b>	50 A	<b>Additional connection modalities</b>	Yes, Double and Three Phase
<b>Voltage</b>	220-240 V	<b>Frequency</b>	50/60 Hz
<b>Voltage 2 (V)</b>	380-415 V	<b>Terminal block</b>	5 poles

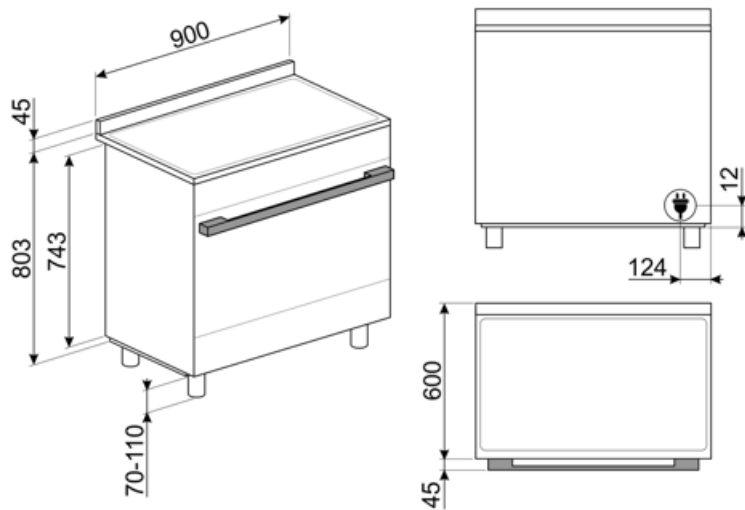

## Not included accessories

### AIRFRY9

Air fryer rack AIRFRY . Ideal for recreating traditional frying in the oven, but with fewer calories and less fat. It allows you to cook quickly and simply dishes such as French fries, fried vegetables and fish, ensuring perfect browning and crispiness.



### BN920

### GRILLPLATE

Universal griddle for induction, gas, ceramic and electric hobs. Non-stick surface ideal for cooking meat, cheese and vegetables. Dimensions: 410 x 240 mm.



### GTT

\*\*Totally extractable telescopic guides (1 level)\*\* Extraction: 433 mm Material: Stainless steel AISI 430 polished



### KITH95CPF9

Height extension kit (950 mm), suitable for Portofino cookers

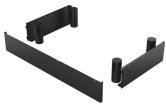

### KITPC9X9

Splashback, 90 cm, for Symphony and Portofino pyrolytic cookers

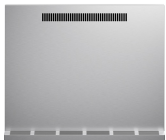

### PALPZ

Pizza shovel with fold away handle width: 315mm length : 325mm



### SCRP

Induction and ceramic hobs and teppanyaki scraper



### BBQ9



### BN940

### GTP

\*\*Partially extractable telescopic guides (1 level)\*\* Extraction: 300 mm Material: Stainless steel AISI 430 polished



### KIT600CPF9P

Cover strip for hob back side, suitable for 90 cm Portofino cookers with piro oven



### KITPBX

Height reduction feet (850 mm)



### KITPD

Height extension black feet (950 mm) for cookers



### PPR9

Refractory pizza stone without handles. Squared shaped stone: L64xH2,3xP37,5 cm Suitable also for gas ovens, to be put on the griddle.



### SFLK1

Child lock



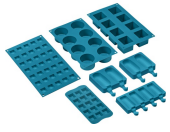

### SMOLD

















Set of 7 silicone moulds for ice creams, ice lollies, pralines, ice cubes or to portion food. Usable from -60°C to +230°C























### TPKPLATE

Universal plate for induction, gas, ceramic and electric hobs. Non-stick surface ideal for cooking fish, eggs and vegetables. Dimensions: 410 X 240 mm.

## Symbols glossary

- |  |   |
|--|---|
|  <p><b>Triple Fan Technology:</b> The oven is equipped with an exclusive three fan system, which, combined with the increased power of the motors, enables excellent cooking performance. The two large side fans distribute the air around the outer perimeter of the cavity while the smaller central fan increases ventilation by creating a vertical vortex of heat. Accordingly, the temperature within the cavity is uniform, allowing food to be cooked evenly on all five levels, like in professional kitchens.</p> |  <p><b>A+:</b> Energy efficiency class A+ helps to save up to 10% energy compared to class A. Maximum performance with minimum consumption is guaranteed.</p>  |
|  <p><b>Installation in column:</b> Installation in column</p>  |  <p><b>Air cooling system:</b> to ensure a safe surface temperatures.</p>  |
|  <p><b>Defrost by time:</b> with this function the time of thawing of foods are determined automatically.</p>  |  <p><b>Defrost by weight:</b> With this function the defrosting time is determined</p>   |
|  <p><b>Quadruple glazed:</b> Number of glazed doors.</p>   |  <p><b>Enamel interior:</b> The enamel interior of all Smeg ovens have a special antacid lining which helps keep the interior clean by reducing the amount of cooking grease adhering to it.</p>   |
|  <p><b>Fan assisted base:</b> the mix of fan and lower heating element alone allows to finish cooking foods already cooked on the surface but not internally more quickly. This system is recommended to finish cooking foods that are already well cooked on the surface, but not internally, which therefore require a moderate higher heat. Ideal for any type of food.</p>   |  <p><b>Fan with upper and lower elements:</b> The elements combined with the fan aim to provide more uniform heat, a similar method to conventional cooking, so pre-heat is required. Most suitable for items requiring slow cooking methods.</p>  |
|  <p><b>Upper and lower element only:</b> a traditional cooking method best suited for single items located in the centre of the oven. the top pf the oven will always be hottest. Ideal for roast, fruit cakes, bread etc.</p>   |  <p><b>Lower heating element only:</b> This function is ideal for foods that require extra base temperature without browning, e.g. pastry dishes, pizza. Also suitable for slow cooking of stews and casseroles.</p>   |
|  <p><b>Circulaire:</b> The combination of the fan and circular element around it gives a hot air cooking method. This provides many benefits including no preheat if cook time is more than 20 minutes, no flavour transfer when cooking different foods at the same time, less energy, and shorter cook times. Good for all types of food.</p>  |  <p><b>ECO:</b> The combination of the grill, fan and lower element is particularly suitable for cooking small quantities of food.</p>   |
|  <p><b>Grill element:</b> Using of grill gives excellent results when cooking meat of medium and small portions, especially when combined with a rotisserie (where possible). Also ideal for cooking sausages and bacon.</p>   |  <p><b>Half grill:</b> For rapid cooking and browning of foods. Best results can be obtained by using the top shelf for small items, the lower shelves for larger ones, such as chops or sausages. For half grill heat is generated only at the centre of the element, so is ideal for smaller quantities.</p> |

- |  |   |
|--|---|
|  <p>Fan with grill element: The fan reduces the fierce heat from the grill, providing an excellent method of grilling various foods, chops, steaks, sausages etc. giving even browning and heat distribution, without drying out the food. The top two levels recommended for use, and the lower part of the oven can be used to keep items warm at the same time, an excellent facility when cooking a grilled breakfast. Half grill (centre portion only) is ideal for small quantities of food.</p> |  <p>Circulaire with upper and lower elements: The use of the fan with both elements allows food to be cooked quickly and effectively, ideal for large joints that require thorough cooking. It offers a similar result to rotisserie, moving the heat around the food, instead of moving the food itself, enabling any size or shape to be cooked.</p> |
|  <p>Overheat protection: The safety system that automatically turns off the hob in case of overheating of the control unit.</p>  |  <p>Induction: The work of these hobs is based on the principle of electromagnetic induction. The heat is generated directly in the bottom of the pan during its contact with the hob.</p>   |
|  <p>All glass inner door: All glass inner door, a single flat surface which is simple to keep clean.</p>   |  <p>The inner door glass: can be removed with a few quick movements for cleaning.</p>  |
|  <p>Side lights: Two opposing side lights increase visibility inside the oven.</p>   |  <p>Automatic opening: some models have Automatic opening door when the cycle is finished which is a perfect solution for handle-less kitchen units as no handle is needed. For safety reasons, the door locks automatically when the machine is in use to avoid it being opened inadvertently.</p>  |
|  <p>Pyrolytic: Pyrolytic cleaning cycles can be selected as necessary to automatically clean the oven interior.</p>  |  <p>Pyrolytic: The Eco pyrolytic cleaning function can be selected when the oven has a lighter build up of dirt. This function has a maximum duration of 1.5 hours.</p>  |
|  <p>Air at 40°C provides the perfect environment for proving yeast type dough mixes. Simply select the function and place dough in the cavity for allotted</p>   |  <p>Indication of residual heat: After the glass ceramic hob is switched off the residual heat indicator shows which of the heating zones still remains hot. When the temperature drops below 60 ° C, the indicator goes out.</p>  |
|  <p>Sabbath: This function allows you to cook food whilst respecting the provisions of the Jewish day of rest.</p>   |  <p>The oven cavity has 5 different cooking levels.</p>  |
|  <p>Soft close: all models are equipped with advanced function of smooth closing of the door, which allows the device to close smoothly and quietly.</p>   |  <p>Telescopic rails: allow you to pull out the dish and check it without having to remove it from the oven entirely.</p>  |
|  <p>Electronic control: Allows you to maintain temperature inside the oven with the precision 2-3 ° C. This enables to cook meals that are very sensitive to temperature changes, such as cakes, souffles, puddings.</p>   |  <p>The capacity indicates the amount of usable space in the oven cavity in litres.</p>  |
|  <p>...</p>  |  <p>Knobs control</p>  |



---

## Benefit

---

### **Induction hob**

Induction offers fast cooking and precise temperature control

Through the use of suitable cookware, induction is easy to use and maintain, safe and responsive

### **Pyrolysis**

Easy oven cleaning thanks to special pyrolytic function

### **LCD display**

Easy and intuitive user-experience and cook with a simple touch.

### **Push-pull storage compartment**

More space thanks to the lower push-pull compartment, ideal for storing accessories or cooking utensils

### **Circulaire**

The best cooking performances guaranteed by ventilated circular flow.

Multiple fans and heating elements guarantee the perfect aerodynamic heat flow, allowing homogeneous and quicker cooking inside the cavity.

### **Multilevel cooking**

Several cooking levels allow maximum flexibility of use

### **Multilevel halogen light**

Internal halogen lighting on different levels guarantees excellent visibility

### **Removable inner glass**

Internal door glasses are easily removable for complete cleaning

### **Tangential cooling**

New cooling system with tangential fan and airflow from the door to the splashback

### **Electronic control**

Electronic control for timely temperature management and heat uniformity

### **Telescopic guides**

Easy extraction and safe insertion of trays into the oven thanks to telescopic guides

### **Isothermic Cavity**

The best cooking performance at the highest energy efficiency

**Adjustable height**

Cooker top flushed with the working area thanks to adjustable feet

**BBQ (optional accessory)**

Barbeque cooking directly in the oven with the double-sided grill

**Pizza stone (optional accessory)**

Baking with refractory stone for soft and crispy pizza and yeast products (STONE optional accessory)

**Cold door**

During any function, the external door glass is cold, avoiding any risk of burns

**AirFry (AIRFRY optional accessory)**

Lighter and tastier food thanks to airfry basket

**Soft close**

The door is equipped with a specific system for silent closing

**Triple Turbine**

The oven has three fans and two circular heating elements, allowing cooking with rotating heat

**Sabbath mode**

Possibility of cooking food in compliance with the provisions of the Jewish religious holiday of rest, thanks to Sabbath mode