

# CPV115B3

Familie	Lade
Nishoogte	14 cm
Type	Vacumeerlade
Vitality system	Ja







## Design

Esthetiek	Linea	Materiaal	Glas
Kleur	Zwart	Logo	Geëtst
Afwerking	Neptune Grey	Positie logo	Inside







## Bediening

Type bediening	Touch control
----------------	---------------

## Program / Functions

Cyclus vacuüm in zakjes	
Cyclus vacuüm in container	
Chef functie	
Sealen/sluiten	

## Technische specificaties

					
Openmechanisme	Push-pull	Veiligheidsmagneetventiel	Ja		
Materiaal onderkant	Stainless steel 304	anti olie reflux			
Materiaal deksel	Gehard glas met frame	Ontvochtigings pompcyclus	Ja, automatisch		
Deksel opening	65° +/- 3°				

<b>Apparaat stabilisatie</b>	Ja	<b>Enabling vacuum bar lenght</b>	260 mm
<b>Max. uitsteek lade</b>	453 +/- 2 mm	<b>Removable enabling vacuum bar</b>	Ja
<b>Max. toegestaan gewicht</b>	15 kg	<b>Type lassen</b>	Double-phase
<b>Max. vulgewicht lade</b>	48 kg	<b>Duur van de conserveringscyclus</b>	1' - 1'20"
<b>Capaciteit</b>	6,5 l	<b>Te bereiken vacuüm</b>	2-10 millibar (99,9%)
<b>Pump flow</b>	4 m <sup>3</sup> /h	<b>Vacuüm sensor</b>	Yes, accuracy 10 mbar
		<b>Inbegrepen accessoires</b>	20x30 V-bags, 25x35 V-Bags

## Elektrische aansluiting

<b>Stekker</b>	(F;E) Schuko	<b>Spanning (V)</b>	220-240 V
<b>Nominale aansluitwaarde</b>	240 W	<b>Frequentie (Hz)</b>	50-60 Hz
<b>Stroom</b>	1 A		

## Logistieke informatie

<b>Breedte product</b>	597 mm	<b>Hoogte product</b>	135 mm
<b>Diepte product</b>	570 mm		

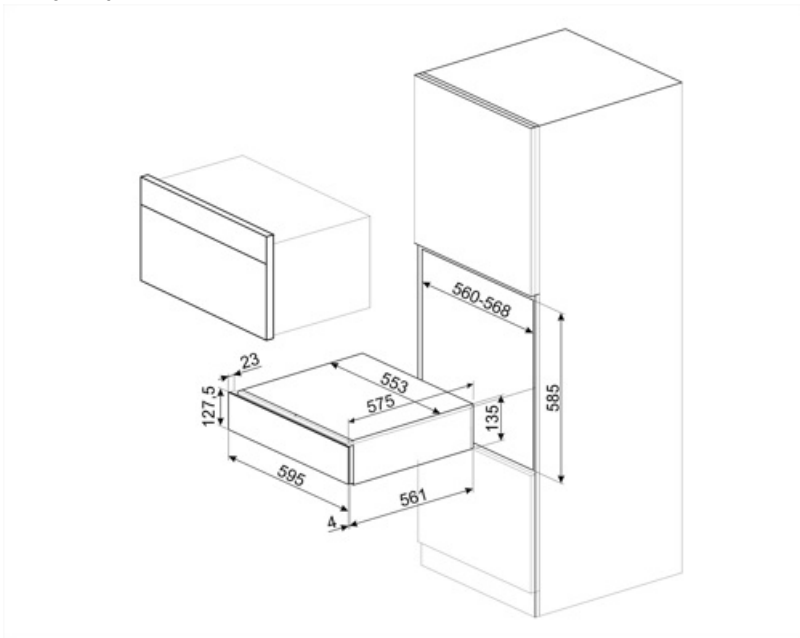

---

## Accessoires niet inbegrepen

---



### LIFEBOX

Set of 3 containers for vacuum drawer



### VBAG1











Bags for sous-vide cooking and preservation, 20x30, 50 pieces



### VBAG2

Bags for sous-vide cooking and preservation, 25x35, 50 pieces

## Symbols glossary

- |  |   |   |  |
|--|---|---|--|
|    | The Chef function alternates compression and decompression cycles and speeds up some operations, such as marinade or infusion, that otherwise would require a lot of time.  |    | Vacuümszakken. Deze zakken zijn bestand tegen temperaturen van -25 ° C tot 70 ° C (gedurende 2 uur) of 100 ° C (gedurende 15 minuten). Geschikt voor voorraadmasten, koelkasten en vriezers, ze kunnen niet worden gebruikt voor vacuümkokken. |
|    | The vacuum in bag function guarantees to create vacuum into bags choosing among three levels. It is also possible to set the 0 level to seal the bag without creating the vacuum.   |    | The stabilization device maintains the drawer open when used, avoiding closing it accidentally.  |
|    | Sous-vide cooking bags. These bags endure a maximum temperature of 85°C (for 75 hours), 100°C (for 4 hours) or 121°C (for 30 minutes). Suitable for pantry and refrigerator storage, they cannot be storage in the freezer. |    | The vacuum in container function guarantees to create vacuum into glass or plastic containers choosing among three different levels. Use only certificate containers suitable for vacuum and able to resist to a 99,9% vacuum.                 |
|    | Setting the highest vacuum in bag/container level, it is reached a 99,9% vacuum.  |    | The vacuum sensor guarantees the achievement of the maximum vacuum connected to the level set. If the value is not reached, the bag is not sealed.   |
|  | The machine can be set at three different sealing levels. Setting the maximum level is possible to seal more bags at the same time with a unique cycle.   |  | The machine carries out a double phase welding which guarantees to seal dirty and oily bags as well.   |

## Benefit (TT)

---

### Deuropening met push-pull

Met een eenvoudige duw opent de lade en sluit deze weer door hem terug te duwen.

### Conserveringscyclus

3 conserveercycli (delicaat, conservering, sous vide)

### Vacuüm in container cyclus

3 vacuümniveaus (delicaat, gemiddeld, sterk)

### Chef-modus

Perfekte marinades en infusies dankzij de Chef-modus

### Vitaliteitssysteem

Het gecombineerde gebruik van de stoomoven, blast chiller en vacuümlade maakt het behoud van producteigenschappen en maximale smaakversterking mogelijk.