

# CVI121G



<b>Product Family</b>	Wine Cooler
<b>Installation</b>	Built-in
<b>Built-In Niche</b>	45 cm
<b>Defrost</b>	Automatic
<b>Cooling type</b>	Fan assisted
<b>Hinge type</b>	Variable hinge
<b>Hinge position</b>	Right
<b>Reversible door</b>	Yes



## Wine cooler compartment features



<b>Number of fixed shelves</b>	1
<b>Number of removable shelves</b>	2
<b>No. of lights</b>	1
<b>Shelves material</b>	Wood
<b>Removable shelves on telescopic guide rails</b>	Yes
<b>Type of internal light</b>	LED
<b>Air filter</b>	Activated charcoal filter

## Programs / Functions



<b>Control setting</b>	Touch control	<b>Control lock</b>	Yes
<b>Controls</b>	Internal, in the compartment	<b>Lighting forced ON</b>	In a maximum period
<b>Display</b>	LCD	<b>Fan forced ON</b>	Yes
<b>Functions display</b>	Temperature alarm, Temperature value	<b>Temperature Alarm</b>	Yes
<b>Power on lamp</b>	Yes	<b>Door open alarm</b>	Yes

## Technical Features

<b>Adjustable temperature zones</b>	1	<b>Number of compressors</b>	1
		<b>Compressor type</b>	Low vibration compressor
		<b>Refrigerant gas type</b>	R600a

<b>Independent cooling systems</b>	1	<b>Refrigerant Quantity (gr)</b>	20 g
<b>Number of door glasses</b>	2	<b>Foam agent</b>	HFO
<b>Temperature range</b>	5-20 °C	<b>Metal panel on the back of the fridge</b>	Metal
<b>Type of temperature control</b>	Electronic	<b>Door opening type</b>	With push pull system
<b>Anti-UV door glass</b>	Yes		
<b>Integrated heating element</b>	Yes		

## Performance / Energy Label







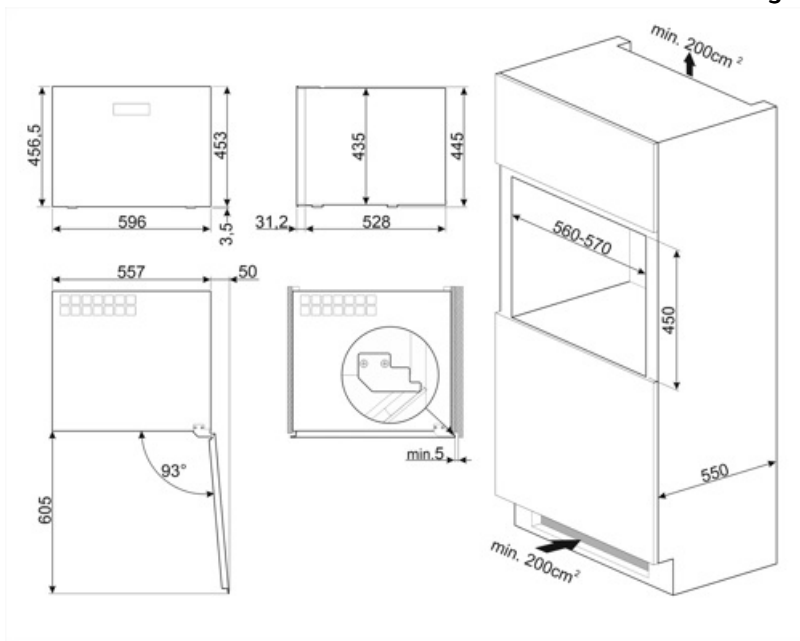

			
<b>Annual energy consumption</b>	100 kWh/year	<b>Sum of the volumes of the chill compartment(s) and the unfrozen compartment(s)</b>	56 l
<b>Energy efficiency class</b>	F	<b>Climatic class</b>	SN, N, ST
<b>Airborne acoustical noise emission class</b>	C	<b>EEl</b>	124 %
<b>Total volume</b>	56 l	<b>Noise level</b>	36 dB(A) re 1 pW

## Electrical Connection

<b>Plug</b>	(F;E) Schuko	<b>Voltage (V)</b>	220-240 V
<b>Nominal power</b>	40 W	<b>Frequency (Hz)</b>	50 Hz
<b>Current</b>	0,4 A	<b>Power supply cable length</b>	180 cm



## Symbols glossary

-  The automatic defrost system works by automatically defrosting at regular intervals eliminating the need to defrost altogether.
-  Energy efficiency class F
-  Ventilated: Forced distribution of cold air in the refrigerator compartment, which allows even temperature distribution within the fridge.
-  Built-in niche
-  A+: Energy efficiency class A+ helps to save up to 10% energy compared to class A. Maximum performance with minimum consumption is guaranteed.
-  LCD display: to optimize performance and simplify the use of the appliance.
-  LED interior lighting: is a more energy efficient and long lasting way of illuminating the interior of the appliance.
-  Touch controls: Easy to use touch controls allow the appliance to be programmed at the touch of a button.