

# CX93IMBL

Cooker size	90x60 cm
N. of cavities with energy label	2
Cavity heat source	Electric
Hob type	Induction
Type of main oven	Thermo-ventilated
Type of second oven	Thermo-ventilated
EAN code	8017709340636
Energy efficiency class	A
Energy efficiency class, second cavity	B



## Aesthetics



<b>Aesthetics</b>	Classic	<b>Control knobs</b>	Smeg Classic
<b>Series</b>	Concert	<b>Controls colour</b>	Stainless steel
<b>Design</b>	Standard	<b>No. of controls</b>	8
<b>Colour</b>	Black	<b>Serigraphy colour</b>	Silver
<b>Finishing</b>	Gloss Black	<b>Display</b>	Touch
<b>Command panel finish</b>	Enamelled metal	<b>Door</b>	With frame
<b>Logo</b>	Assembled	<b>Glass type</b>	Black
<b>Logo position</b>	Command panel	<b>Handle</b>	Smeg Classic
<b>Hob colour</b>	Black enamel	<b>Handle Colour</b>	Brushed stainless steel
<b>Type of control setting</b>	Hybrid: Knobs + Digi Touch	<b>Feet</b>	Black

## Programs / Functions

No. of cooking functions	1
Traditional cooking functions	



Circulaire

## Programs / Functions Auxiliary Oven

Cooking functions cavity 2	1
----------------------------	---

## Programme / Functions Third Oven

No. of functions third oven	1
Oven light	
Full grill	

## Hob technical features

<b>Total no. of cook zones</b>	4
Front left - Induction - single - 1.50 kW - Booster 2.00 kW - - Ø 18.0 cm	
Rear left - Induction - single - 1.50 kW - Booster 2.00 kW - - Ø 18.0 cm	
Rear right - Induction - single - 1.50 kW - Booster 2.00 kW - - Ø 18.0 cm	
Front right - Induction - single - 1.50 kW - Booster 2.00 kW - - Ø 18.0 cm	
<b>Number of Flexible zones</b>	2

## Main Oven Technical Features



<b>No. of lights</b>	1	<b>Removable door</b>	Yes
<b>Fan number</b>	1	<b>Full glass inner door</b>	Yes
<b>Net volume of the cavity</b>	61 litres	<b>Removable inner door</b>	Yes
<b>Gross volume, 1st cavity</b>	70 l	<b>Total no. of door glasses</b>	3
<b>Cavity material</b>	Easy clean enamel	<b>No. of thermo-reflective door glasses</b>	1
<b>Shelf positions</b>	4	<b>Safety Thermostat</b>	Yes
<b>Type of shelves</b>	Metal racks	<b>Cooling system</b>	Tangential
<b>Light type</b>	Halogen	<b>Usable cavity space dimensions (HxWxD)</b>	316x460x412 mm
<b>Light power</b>	40 W	<b>Temperature control</b>	Electro-mechanical
<b>Cooking time setting</b>	Start and Stop	<b>Circular heating element - Power</b>	2000 W
<b>Door opening</b>	Side opening		

## Options Main Oven

<b>Timer</b>	Yes	<b>Minimum Temperature</b>	50 °C
<b>End of cooking acoustic alarm</b>	Yes	<b>Maximum temperature</b>	245 °C

## Second Oven Technical Features



<b>Fan number</b>	1	<b>Full glass inner door</b>	Yes
<b>Net volume of the second cavity</b>	62 litres	<b>No. total door glasses</b>	2
<b>Gross volume, 2nd cavity</b>	69 l	<b>No. thermo-reflective door glasses</b>	1
		<b>Safety Thermostat</b>	Yes
		<b>Cooling system</b>	Tangential

<b>Cavity material</b>	Easy clean enamel	<b>Usable cavity space dimensions (HxWxD)</b>	605x275x370 mm
<b>Shelf positions</b>	9	<b>Temperature control</b>	Electro-mechanical
<b>Type of shelves</b>	Metal racks	<b>Circular heating element - Power</b>	2500 W
<b>Door opening</b>	Side opening		
<b>Removable door</b>	Yes		

## Options Auxiliary Oven

<b>Minimum Temperature</b>	50 °C	<b>Maximum temperature</b>	245 °C
----------------------------	-------	----------------------------	--------

## Third Oven Technical Features



<b>Net volume, 3rd cavity</b>	35 l	<b>No. total door glasses</b>	3
<b>Gross volume, 3rd cavity</b>	41 l	<b>No. of thermo-reflective door glasses</b>	1
<b>Cavity material</b>	Easy clean enamel	<b>Safety Thermostat</b>	Yes
<b>Shelf positions</b>	2	<b>Cooling system</b>	Tangential
<b>Type of shelves</b>	Metal racks	<b>Usable cavity space dimensions (HxWxD)</b>	169x440x443 mm
<b>Door opening</b>	Flap down	<b>Temperature control</b>	Electro-mechanical
<b>Removable door</b>	Yes	<b>Large grill - Power</b>	2700 W
<b>Full glass inner door</b>	Yes	<b>Grill type</b>	Electric
<b>Removable inner door</b>	Yes	<b>Tilting grill</b>	Yes

## Options Third Oven

<b>Minimum Temperature</b>	50 °C	<b>Maximum temperature</b>	260 °C
----------------------------	-------	----------------------------	--------

## Accessories included for Main Oven & Hob

<b>Rack with back and side stop</b>	1	<b>40mm deep tray</b>	1
-------------------------------------	---	-----------------------	---

## Accessories included for Secondary Oven

<b>Chrome shelf with back stop</b>	3
------------------------------------	---

## Electrical Connection

<b>Max Power Draw</b>	15200 W	<b>Type of electric cable</b>	Yes, Single phase
<b>Current</b>	41 A	<b>Additional connection modalities</b>	Yes, Double and Three Phase
<b>Voltage</b>	220-240 V	<b>Frequency</b>	50/60 Hz
<b>Voltage 2 (V)</b>	380-415 V	<b>Terminal block</b>	5 poles

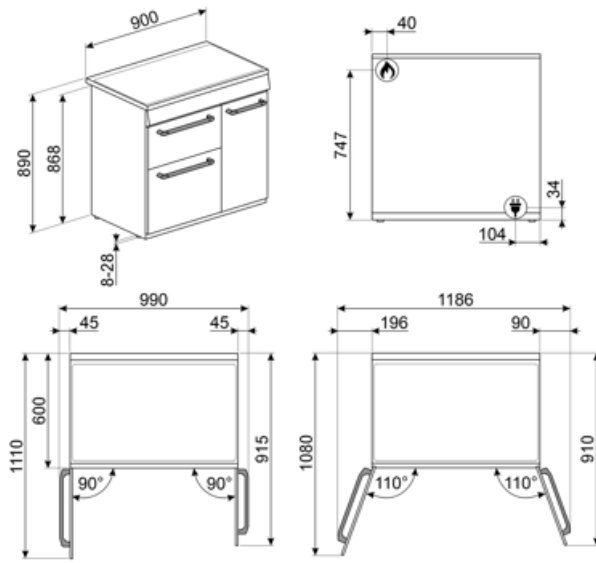

## Not included accessories

### AIRFRY

Air fryer rack AIRFRY . Ideal for recreating traditional frying in the oven, but with fewer calories and less fat. It allows you to cook quickly and simply dishes such as French fries, fried vegetables and fish, ensuring perfect browning and crispiness.



### BG6090-1

Cast iron grill plate suitable for Concert cookers



### BN640

Enamelled tray, 40mm deep



### GRM

Gas hobs moka support



### GTT

\*\*Totally extractable telescopic guides (1 level)\*\* Extraction: 433 mm Material: Stainless steel AISI 430 polished



### KITH93

Height extension kit (950 mm), suitable for TR93 cookers



### PPX6090-1

Stainless steel teppanyaki grill plate suitable for 90cm Concert cookers



### SFLK1

Child lock



### BBQ

Double sided plate BBQ. Suitable for recreating succulent and crispy dishes in the oven with the typical taste of grilled cooking. The ribbed side is particularly suitable for meats and cheeses. The smooth side for fish, seafood and vegetables.



### BN620-1

Enamelled tray, 20mm deep



### BNP608T

Teflon-coated tray, 8mm depth, to be placed on the grid



### GTP

\*\*Partially extractable telescopic guides (1 level)\*\* Extraction: 300 mm Material: Stainless steel AISI 430 polished



### KIT90N9

Splashback 90 cm, black, for BU & BM cookers



### PALPZ

Pizza shovel with fold away handle width: 315mm length : 325mm



### SCRP

Induction and ceramic hobs and teppanyaki scraper



### SMOLD

Set of 7 silicone moulds for ice creams, ice lollies, pralines, ice cubes or to portion food. Usable from -60°C to +230°C

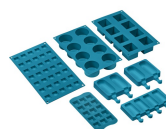

## STONE

Rectangular refractory stone. Ideal for cooking pizzas with the same results as a typical wood-fired oven. Can also be used for baking bread, focaccias and other recipes such as pies, flans or biscuits Dimensions: L42 x H1,8 x P37,5 cm.



























## WOKGHU

Cast-Iron WOK Support



## Symbols glossary

 <p>A: Product drying performance, measured from A+++ to D / G depending on the product family</p>	 <p>Installation in column: Installation in column</p>
 <p>Air cooling system: to ensure a safe surface temperatures.</p>	 <p>The touch timer display or DigiScreen guarantees simple functionality. They display the time, set programmed cooking and the minute minder timer.</p>
 <p>Double glazed doors: Number of glazed doors.</p>	 <p>Triple glazed doors: Number of glazed doors.</p>
 <p>B: Product energy rating, measured from A+++ to D / G depending on the product family.</p>	 <p>Enamel interior: The enamel interior of all Smeg ovens have a special antacid lining which helps keep the interior clean by reducing the amount of cooking grease adhering to it.</p>
 <p>Circulaire: The combination of the fan and circular element around it gives a hot air cooking method. This provides many benefits including no preheat if cook time is more than 20 minutes, no flavour transfer when cooking different foods at the same time, less energy, and shorter cook times. Good for all types of food.</p>	 <p>Grill element: Using of grill gives excellent results when cooking meat of medium and small portions, especially when combined with a rotisserie (where possible). Also ideal for cooking sausages and bacon.</p>
 <p>Light</p>	 <p>Induction: The work of these hobs is based on the principle of electromagnetic induction. The heat is generated directly in the bottom of the pan during its contact with the hob.</p>
 <p>All glass inner door: All glass inner door, a single flat surface which is simple to keep clean.</p>	 <p>The inner door glass: can be removed with a few quick movements for cleaning.</p>
 <p>Side lights: Two opposing side lights increase visibility inside the oven.</p>	 <p>The oven cavity has 2 different cooking levels.</p>
 <p>The oven cavity has 4 different cooking levels.</p>	 <p>The oven cavity has 9 different cooking levels.</p>
 <p>Electronic control: Allows you to maintain temperature inside the oven with the precision 2-3 ° C. This enables to cook meals that are very sensitive to temperature changes, such as cakes, souffles, puddings.</p>	 <p>Tilting grill: the tilting grill can be easily unhooked to move the heating element and clean the roof of the appliance in one simple step.</p>
 <p>TWIN_ZONE_72dpi</p>	 <p>The capacity indicates the amount of usable space in the oven cavity in litres.</p>
 <p>The capacity indicates the amount of usable space in the oven cavity in litres.</p>	 <p>The capacity indicates the amount of usable space in the oven cavity in litres.</p>

---

## Benefit

---

### **Induction hob**

Induction offers fast cooking and precise temperature control

Through the use of suitable cookware, induction is easy to use and maintain, safe and responsive

### **Ever Clean Enamel**

Easy oven cleaning thanks to special pyrolytic enamel

### **Touch control**

Easy and intuitive timer setting with a single touch

### **True-convection**

The best cooking performances guaranteed by ventilated circular flow.

Multiple fans and heating elements guarantee the perfect aerodynamic heat flow, allowing homogeneous and quicker cooking inside the cavity.

### **Multilevel cooking**

Several cooking levels allow maximum flexibility of use

### **Multilevel halogen light**

Internal halogen lighting on different levels guarantees excellent visibility

### **Removable inner glass**

Internal door glasses are easily removable for complete cleaning

### **Tangential cooling**

New cooling system with tangential fan and airflow from the door to the splashback

### **Isothermic Cavity**

The best cooking performance at the highest energy efficiency

### **BBQ (optional accessory)**

Barbeque cooking directly in the oven with the double-sided grill

### **Pizza stone (optional accessory)**

Baking with refractory stone for soft and crispy pizza and yeast products (STONE optional accessory)

### **Adjustable height**

Cooker top flushed with the working area thanks to adjustable feet



#### **Cold door**

During any function, the external door glass is cold, avoiding any risk of burns

#### **AirFry (AIRFRY optional accessory)**

Lighter and tastier food thanks to airfry basket

#### **Single turbine**

The oven has a fan equipped with a circular heating element allowing cooking with rotating heat