

# DF345CQSX



Product Family	Dishwashers
Width	60 cm
Commercial height	85 cm
Installation	Free-standing
N° baskets	3, Flexi
Motor	Inverter 2.0
EAN code	8017709335984



## Programmes



No. of programmes	8	ECO	Yes
Washing temperatures	50, 60, 65, 70 °C	Mix	Yes
Soak	Yes	Intense 60°	Yes
Full express - 60 minutes	Yes	Auto 50°-60°	Yes
Express 50°	Yes		

## Options



Delay timer option	Up to 24 hours, with automatic soak	Crystal option	Yes
Extreme option	Yes	Sterilise option	Yes

## Baskets

Basket colour	Grey	Height adjustment of the upper basket	On two levels (4 cm)
Basket components colour	Grey	Largest loadable dish in upper basket	20,0 cm
Handle	In plastic with stainless steel insert on upper and lower basket	Lower Basket	With 4 foldable racks
Upper Basket	With 3 foldable racks	Largest loadable dish in lower basket	31.0 cm
Glass holder	Yes	Colour Inner Components	Grey

## Technical Features



<b>Width (mm)</b>	598 mm	<b>Water softener</b>	With electronic setting
<b>Depth (mm)</b>	600 mm	<b>Turbidity sensor Aquatest</b>	Yes
<b>Display type</b>	LED display	<b>Flood protection system</b>	Total Acquastop
<b>Product Height (mm)</b>	848 mm	<b>Water supply</b>	Single; cold/hot water max. 60°C - energysave with hot water up to 35%
<b>Controls</b>	Electronic	<b>Max water hardness</b>	90°FH; 50°dH
<b>Display</b>	Delayed start, Programme time indicator, Time to end indication	<b>Drying system</b>	Natural condenser drying, with Dry Assist automatic door opening system at the end of the cycle
<b>Programme graphics</b>	Symbols	<b>Tank material</b>	Stainless steel
<b>Salt light indicator</b>	Light	<b>Filter</b>	Stainless steel
<b>Rinse aid indicator</b>	Light	<b>Concealed heating element</b>	Yes
<b>Progress indicator</b>	Yes	<b>Hinges</b>	Self balancing with fixed hinges
<b>End of cycle indicator</b>	On display, with acoustic signal	<b>Adjustable feet</b>	Just for levelling
<b>Washing system</b>	Orbital	<b>Depth of dishwasher with open door (mm)</b>	1168
<b>Third spray arm</b>	Single	<b>Top cover</b>	In plastic

## Performance / Energy Label



<b>Energy Efficiency Class (Washing cycle)</b>	C	<b>Programme duration</b>	4:00 h:min
<b>Energy consumption [per 100 cycles, based on the eco programme]</b>	75 kWh	<b>Airborne acoustical noise emissions (spinning phase)</b>	44 dB(A) re 1 pW
<b>Rated capacity (ps)</b>	14	<b>Airborne acoustical noise emission class</b>	B
<b>Water consumption [per cycle]</b>	11,0 litres	<b>Energy efficiency Index (EEI) (Washing cycle)</b>	43,9

## Electrical Connection

<b>Plug</b>	(G) UK e Singapore	<b>Frequency (Hz)</b>	50 Hz
<b>Connected power</b>	1950 W	<b>Type of connection</b>	Single-phase
<b>Current</b>	10 A	<b>Power supply cable length</b>	150 cm
<b>Voltage</b>	220-240 V		

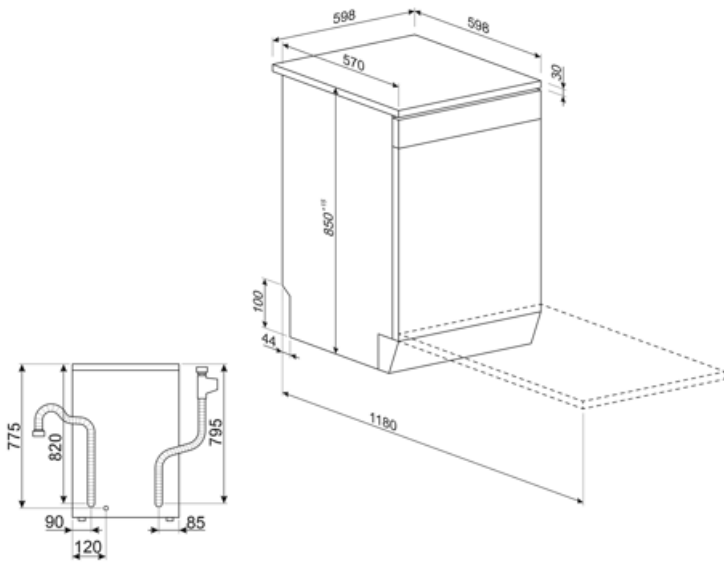

---

## Not included accessories

---

### KITINC

a steel bar fitted on the top will block the dishwasher at the top.

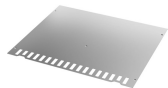



















### KITPLV2

Kit extension for dishwasher and washing machine: length mt. 2



## Symbols glossary

 <p>Aquatest measures the clarity of the water during an auto program, and automatically ensures the minimum consumption of water and energy.</p>	 <p>Delay Timer: The delay timer can postpone the start of the program by up to 24 hours.</p>
 <p>Noise Level: Excellent insulation and special devices keep noise to a minimum.</p>	 <p>Orbital wash system distributes water evenly throughout the 60cm dishwasher cavity, directing water with precision to ensure an excellent wash.</p>
 <p>Eco: Eco, this economic wash programme uses a low amount of water and energy in order to provide the most environmentally friendly cleaning option.</p>	 <p>Normal programme: The normal programme is suitable for normal degrees of dirt for everyday use.</p>
 <p>Soak programme: The soak programme provides a rinse to prevent dirt from drying.</p>	 <p>The symbols show the number of plate settings of the dishwasher.</p>
 <p>Total Acquastop: In addition to the partial Acquastop protection present in all Smeg dishwashers, some models have an electronic device fitted to the water intake hose, which monitors water levels in the machine, detects leaks in the hose and switches off the water supply immediately when necessary.</p>	 <p>...</p>
 <p>...</p>	 <p>Wash cycle for normally soiled mixed loads such as dishes and pans, even with dried-on residues. When this program is selected, the dishwasher recognises the type of dirt and automatically adjusts the washing parameters as appropriate.</p>
 <p>This option provides special care for a delicate load. It prevents rapid changes in the wash temperature of the selected programme and reduces it to 4</p>	 <p>Programme suitable for washing and drying heavily soiled items with encrusted residues.</p>
 <p>Option which improves the washing results of the selected programme. It increases the wash temperature and duration.</p>	 <p>Option which provides better cleaning results by keeping the temperature between 65 and 70°C for at least 10 minutes during the last rinsing phase.</p>
 <p>Energy efficiency class C</p>	 <p>The work aimed at continuous improvement has allowed the creation of the second generation of the Inverter motor 2.0, characterised by greater efficiency and durability over time, which allows very high performance and a lower energy consumption and noise level.</p>