

DFFABBL



Product Family	Dishwashers
Width	60 cm
Commercial height	85 cm
Installation	Free-standing
N° baskets	3, FlexiDuo
Motor	Inverter 2.0
EAN code	8017709307868



Programmes



No. of programmes	10+1	Auto sensor 45-65	Yes
Washing temperatures	38, 45, 50, 55, 65, 70, 75 °C	Mix	Yes
Soak	Yes	Quiet (-2 dB)	Yes
Express 27'	Yes	Intense	Yes
Crystal	Yes	Self clean	Yes
Full express - 60 minutes	Yes	Hygiene 99,9%	Yes
ECO	Yes		

Options



Dry Assist+ option	Yes	1/2 load FlexiZone option (varied distribution)	Yes
Delay timer option	Up to 9 hours, with automatic soak	Special programs option	Yes

Baskets



Basket colour	Grey	Largest loadable dish in upper basket	19,0 cm
Basket components colour	Grey	Lower Basket	With 4 foldable racks

Handle	In plastic on upper and lower basket	Lower basket with anti-drip inserts	Yes
Upper Basket	With 3 foldable racks	Largest loadable dish in lower basket	30,0 cm
Glass holder	Yes	Colour Inner Components	Grey
Height adjustment of the upper basket	On three levels	Cutlery basket	Yes
Upper basket with EasyGlide System	Yes		

Technical Features



Width (mm)	598 mm	Turbidity sensor Aquatest	Yes
Depth (mm)	627 mm	Flood protection system	Total Acquastop
Display type	1 digit	Water supply	Single; cold/hot water max. 60°C - energysave with hot water up to 35%
Product Height (mm)	885 mm	Max water hardness	100°FH;58°dH
Controls	Electronic	Drying system	Natural condenser drying, with Dry Assist + automatic door opening system at the end of the cycle
Display	Delayed start	Tank material	Stainless steel
Programme graphics	Symbols and label	Filter	Stainless steel
On/off indicator	Yes	Concealed heating element	Yes
Salt light indicator	Light	Hinges	Self balancing with fixed hinges
Rinse aid indicator	Light	Adjustable feet	Just for levelling
End of cycle indicator	Acoustic signal	Back cover	Yes
Washing system	Planetarium	Depth of dishwasher with open door (mm)	1171
Third spray arm	Single	Top cover	In plastic
Water softener	With electronic setting		

Performance / Energy Label

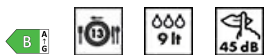

Energy Efficiency Class (Washing cycle)	B	Programme duration	4:25 h:min
Energy consumption [per 100 cycles, based on the eco programme]	63 kWh	Airborne acoustical noise emissions (spinning phase)	45 dB(A) re 1 pW
Rated capacity (ps)	13	Airborne acoustical noise emission class	C
Water consumption [per cycle]	9,0 litres	Energy efficiency Index (EEI) (Washing cycle)	37,9

Electrical Connection

Plug	(G) UK e Singapore	Frequency (Hz)	50 Hz
Connected power	1800 W	Type of connection	Single-phase
Current	13 A	Power supply cable length	140 cm
Voltage	220-240 V		

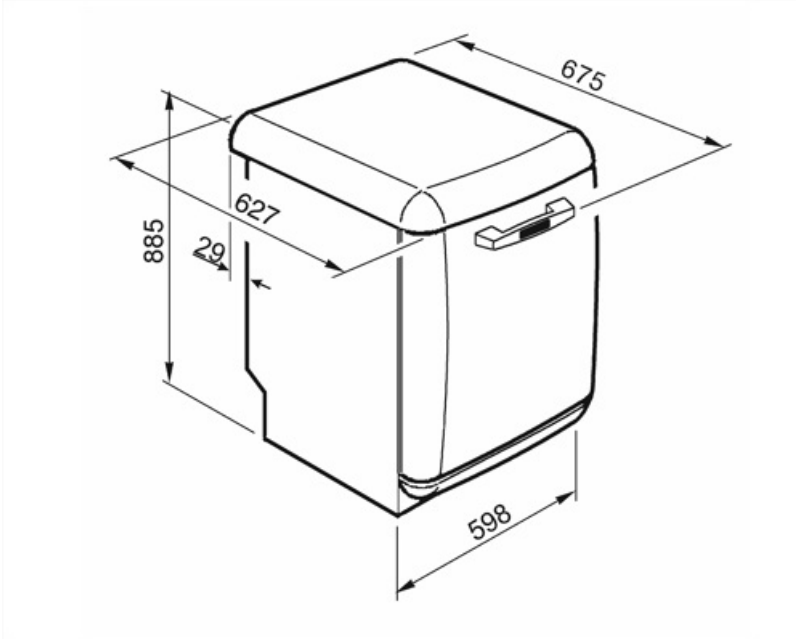

Not included accessories

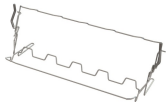

KITGH

Kit glass holder. It has to be fitted on the first basket but only if there are foldable racks

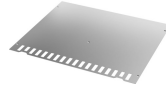

KITINC

a steel bar fitted on the top will block the dishwasher at the top.



KITPLV2

Kit extension for dishwasher and washing machine: length mt. 2

























Alternative products



DFFABCR

Colour: Cream

Symbols glossary

	Aquatest measures the clarity of the water during an auto program, and automatically ensures the minimum consumption of water and energy.		Anti-drip: Some models of dishwashers are equipped with special polymer nozzles anti-drip, that improve the process of drying.
	Energy efficiency class B		Delay Timer: The delay timer can postpone the start of the program by up to 24 hours.
	The Dry Assist + option, in addition to saving energy, ensures perfect drying of the dishes by opening the door automatically at the end of the wash cycle.		EasyGlide: Convenient EasyGlide system for easy unloading of the appliance that allows reaching maximum flexibility of load of the machine.
	FlexiDuo: The FlexiDuo 3rd cutlery basket allows you to arrange cutlery or small cups, ladles, or bulky utensils however you like: it consists of two separate and moveable modules.		FlexiZone: The 1/2 load flexizone allows you to wash a reduced load saving energy, water and time and there are no restrictions on where the items are placed.
	Noise Level: Excellent insulation and special devices keep noise to a minimum.		PLANETARIUM_WASHING_SYSTEM_72dpi
	Auto 45°- 65°: The auto programme regulates the length of a cycle depending on the need for a pre-wash and the number of rinses required.		Crystals: The Crystals programme is dedicated to delicate dishes such as glasses and china.
	Eco: Eco, this economic wash programme uses a low amount of water and energy in order to provide the most environmentally friendly cleaning option.		Normal programme: The normal programme is suitable for normal degrees of dirt for everyday use.
	Soak programme: The soak programme provides a rinse to prevent dirt from drying.		Rapid 27 Mins: The rapid 27 mins quick program takes just 27 minutes to wash a load.
	Ultraclean: The Ultraclean option performs a final rinse at a high temperature of 70°C eliminating virtually all bacteria.		The symbols show the number of plate settings of the dishwasher.
	...		Total Acquastop: In addition to the partial Acquastop protection present in all Smeg dishwashers, some models have an electronic device fitted to the water intake hose, which monitors water levels in the machine, detects leaks in the hose and switches off the water supply immediately when necessary.
	System WaterSave ensures the best washing results with minimal water consumption depending on the model of dishwasher.		...
	...		...



HYGIENE 99.9% High-temperature washing programme. The 75° rinse guarantees the removal of 99.9% of germs and bacteria, making it ideal for sanitising



The work aimed at continuous improvement has allowed the creation of the second generation of the Inverter motor 2.0, characterised by greater efficiency and durability over time, which allows very high performance and a lower energy consumption and noise level.

Benefit

FlexiDuo

The flexible third basket provides additional space, adapting to the load to accommodate various types of dishes, ensuring optimal organization and efficient use of interior capacity

The third FlexiDuo basket consists of two separate sections that can be handled independently of each other, stacked and/or removed, offering loading flexibility for every need. Depending on the arrangement, it allows cups, tall glasses, bulky utensils and pots and pans to be placed in the upper basket.

Planetarium Wash System

Full and deep wash coverage thanks to the advanced movement of the spray arm, an innovation patented by Smeg

Smeg's patented Planetarium Wash System guarantees impeccable cleaning. With a simultaneous double movement of the sprayer and 65 rotations per minute, it reaches every nook and cranny for extraordinary results. Dishes, glasses and utensils will be perfectly clean in no time. An intelligent system where efficiency and style meet, delivering brilliant results effortlessly.

DryAssist+

The Dry Assist+ system of automatic door opening at the end of the cycle ensures fast and energy-efficient drying