

DWA6214W2

Product Family	Dishwashers
Commercial width	60 cm
Commercial height	85 cm
Installation	Free-standing
N° baskets	2
EAN code	8017709278823



Programs



N. of programmes	5	Ultraclean	Yes
Washing temperatures	45, 55, 65, 70 °C	Intensive 65°	Yes
Soak	Yes	Normal ECO	Yes
ECO	Yes		

Options



Delay timer option	3-6-9 hours	Options for tabs FlexiTabs	Yes
--------------------	-------------	----------------------------	-----

Baskets



Basket colour	Grey	Lower Basket	With 2 foldable racks
Basket components colour	Grey	Lower basket with anti-drip inserts	Yes
Handle	In plastic on upper and lower basket	Largest loadable dish in lower basket	30,0 cm
Upper Basket	With central fixed racks	Colour Inner Components	Grey handles, Grey pastic plate for regulation second basket on three levels, Green Orbital
Height adjustment of the upper basket	On three levels	Cutlery basket	13 place settings sliding
Largest loadable dish in upper basket	25,0 cm		

Technical Features



Width (mm)	598 mm	Water supply	Single; cold/hot water max. 60°C - energysave with hot water up to 35%
Depth (mm)	600 mm	Max water hardness	100°FH;58°dH
Product Height (mm)	848 mm	Drying system	Natural condenser drying
Controls	Electronic	Tube material	Stainless steel
Programme graphics	Symbols	Filter	Stainless steel
On/off indicator	Yes	Concealed heating element	Yes
Rinse aid indicator	Light	Hinges	Self balancing with fixed hinges
End of cycle indicator	Led on display, with acoustic signal	Adjustable feet	Just for levelling
Washing system	Orbital	Back cover	Yes, with covered counterweight
Third spray arm	Single	Depth of dishwasher with open door (mm)	1168
Flood protection system	Total Acquastop	Removable top	Yes, with optional KIT

Electrical Connection

Plug	(I) Australia	Frequency (Hz)	50 Hz
Connected power	1800 W	Type of connection	Single-phase
Current	10 A	Power supply cable length	140 cm
Voltage	220-240 V		

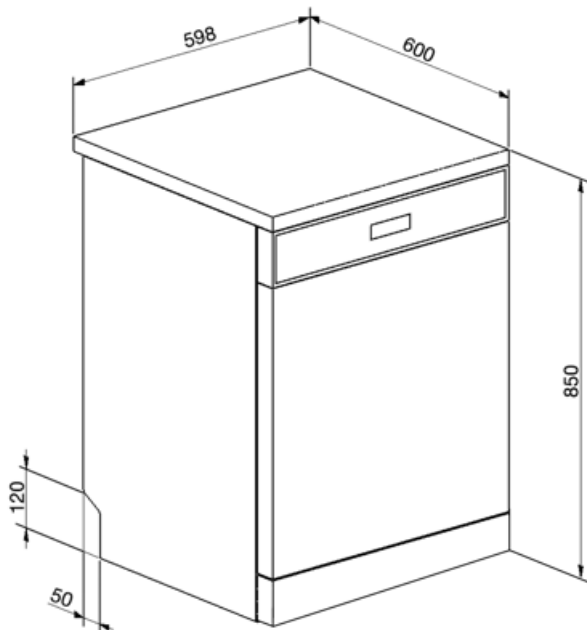

Not included accessories

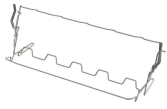

KITGH

Kit glass holder. It has to be fitted on the first basket but only if there are foldable racks

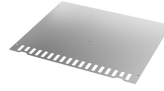

KITINC











a steel bar fitted on the top will block the dishwasher at the top.



KITPLV2

Kit extension for dishwasher and washing machine: lenght mt. 2

Symbols glossary

	Anti-drip: Some models of dishwashers are equipped with special polymer nozzles anti-drip, that improve the process of drying.		Delay Timer: The delay timer can postpone the start of the program by up to 24 hours.
	Flexitabs: Flexitabs adjusts the wash cycle to give the best possible results regardless of the type of detergent used.		Noise Level: Excellent insulation and special devices keep noise to a minimum.
	Orbital wash system distributes water evenly throughout the 60cm dishwasher cavity, directing water with precision to ensure an excellent wash.		Eco: Eco, this economic wash programme uses a low amount of water and energy in order to provide the most environmentally friendly cleaning option.
	Soak programme: The soak programme provides a rinse to prevent dirt from drying.		REF_PRG_NORMAL_ECO_72dpi
	The symbols show the number of plate settings of the dishwasher.		Total Acquastop: In addition to the partial Acquastop protection present in all Smeg dishwashers, some models have an electronic device fitted to the water intake hose, which monitors water levels in the machine, detects leaks in the hose and switches off the water supply immediately when necessary.
	System WaterSave ensures the best washing results with minimal water consumption depending on the model of dishwasher.		