

# FAB10RWH5



Product Family	Refrigerator
Installation	Free Standing
Category	One Door
Reference width	Until 60
Reference height	Until 100
Cooling type	Static
Defrost	Automatic for refrigerator, manual for freezer
Hinge type	Standard
Hinge position	Right
EAN code	8017709298906



## Aesthetics

Aesthetics	50's Style	Handle colour	Chrome
Colour	White	Logo colour	Chrome
Finishing	Gloss	Side material	Steel
Design	Rounded	Side colour	White
Material	Heat-moulded	Logo	Applied
Handle	External	Door shelves profile colour	Silver
Handle type	Fixed	Colour of glass shelf profile	Silver

## Refrigerator compartment features



No. of adjustable shelves	1	Crisper Cover	Yes
Number of fruit and vegetables drawers	1	Type of crisper/vegetable drawers cover	Glass
Type of adjustable shelves	Glass	Internal light in fridge	Yes
Type of crisper/vegetable drawers cover	Standard	Type of internal light (fridge)	LED

## Refrigerator Inner Door

Number of adjustable door shelves	2	No. of bottle shelves	1
-----------------------------------	---	-----------------------	---

## Freezer compartment features

Internal freezer compartment Yes

## Other technical features



Antibacterial Gasket	Yes
Type of temperature control	Electro-mechanical
No. of compressors	1
Refrigerant gas type	R600a
Type of compressor	Standard
Refrigerant Quantity (gr)	25 g
Foam agent	Cyclopentane

## Performance / Energy Label



Annual energy consumption	142 KWh/year	Noise level	37 dB(A) re 1 pW
Energy efficiency class	E	Thaw time	9 h
Airborne acoustical noise emission class	C	4 star - Freezing capacity	2.6 Kg/24h
Total volume	122 l	Climatic class	SN, N, ST, T
Sum of the volumes of the frozen compartment(s)	17 l	EEl	98 %
Sum of the volumes of the chill compartment(s) and the unfrozen compartment(s)	105 l		

## Electrical Connection



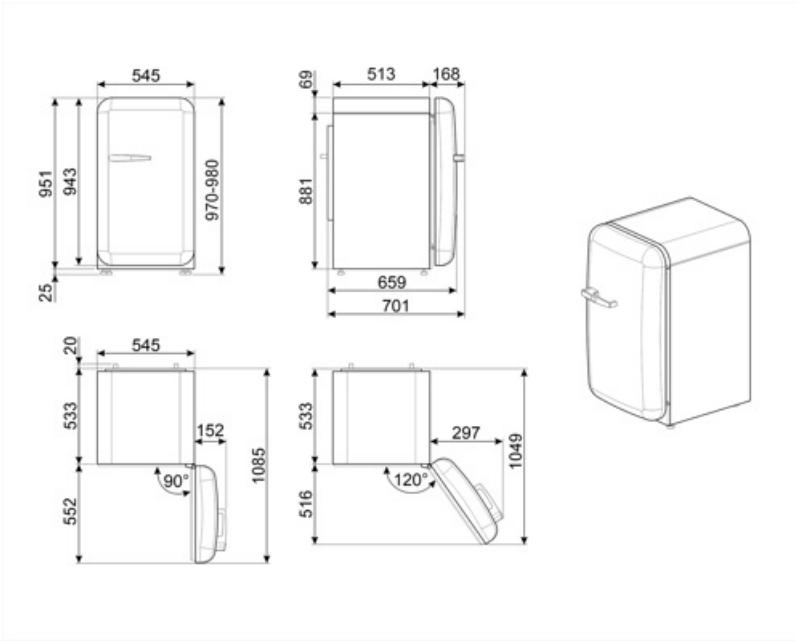



Plug	(F;E) Schuko	Voltage (V)	220-240 V
Nominal power	50 W	Frequency (Hz)	50 Hz
Current	0.42 A	Power supply cable length	180 cm



---

## Symbols glossary

---

- |  |   |   |  |
|--|---|---|--|
|  | 4 stars freezing compartment for better food preservation.                |  | The automatic defrost system works by automatically defrosting at regular intervals eliminating the need to defrost altogether.                  |
|  | Antibacterial treatment: antibacterial treatment to ensure better hygiene |  | A++: Energy efficiency class A++ helps to save up to 20% energy compared to class A. Maximum performance with minimum consumption is guaranteed. |
|  | Energy efficiency class E   |  | LED interior lighting: is a more energy efficient and long lasting way of illuminating the interior of the appliance.                            |