

FAB30LPB5UK



Product Family	Refrigerator
Installation	Free Standing
Category	Top Mount
Reference width	Until 60
Cooling type	Fan assisted refrigerator, static freezer
Defrost	Manual
Hinge type	Standard
Hinge position	Left
EAN code	8017709298418



Aesthetics

Aesthetics	50's Style	Logo colour	Chrome
Colour	Pastel Blue	Side material	Steel
Finishing	Gloss	Side colour	Pastel blue
Design	Rounded	Logo	Applied
Material	Heat-moulded	Door shelves profile colour	Chrome
Handle	External	Drawers profile colour	Chrome
Handle type	Fixed	Colour of glass shelf profile	Chrome
Handle colour	Chrome	Colori disponibili	Orange, Pastel blue, White, Blue, Black, Cream, Pink, Red, Silver, Pastel green, Lime green

Refrigerator compartment features



No. of adjustable shelves	2	Type of crisper/vegetable drawers cover	Glass
Number of fruit and vegetables drawers	1	Life Plus zone-0°C	Yes
Type of adjustable shelves	Glass	Internal light in fridge	Yes
Type of crisper/vegetable drawers cover	On sliding rails	Type of internal light (fridge)	LED
Crisper Cover	Yes		

Refrigerator Inner Door

No. of door shelves with transparent cover	1	No. of bottle shelves	1
Number of adjustable door shelves	2	Bottle shelves with wire support	Yes
Adjustable door shelves with wire support	Yes		

Other Refrigerator features



MultiFlow	Yes	Fan	Yes
-----------	-----	-----	-----

Freezer compartment features

No. of shelves	1	Type of shelves	Wire
----------------	---	-----------------	------

Other Freezer features

Ice tray shelf	Yes
----------------	-----

Other technical features



Door open alarm	Acoustic and visual
Type of temperature control	Electronic
No. of compressors	1
Refrigerant gas type	R600a
Type of compressor	Variable Speed Compressor
Refrigerant Quantity (gr)	70 g
Foam agent	Cyclopentane

Performance / Energy Label



Annual energy consumption	168 KWh/year	Noise level	37 dB(A) re 1 pW
Energy efficiency class	D	Thaw time	30 h
Airborne acoustical noise emission class	C	4 star - Freezing capacity	4 Kg/24h
Total volume	294 l	Climatic class	SN, N, ST, T
		EEl	80 %

Sum of the volumes of the frozen compartment(s) 72 l

Sum of the volumes of the chill compartment(s) and the unfrozen compartment(s) 222 l

Electrical Connection

Plug	(G) UK e Singapore	Voltage (V)	220-240 V
Nominal power	100 W	Frequency (Hz)	50/60 Hz
Current	0,8 A	Power supply cable length	180 cm

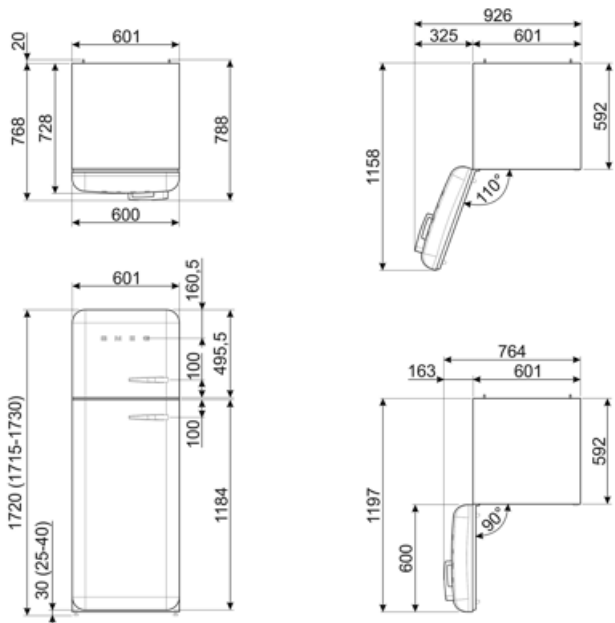

Alternative products



FAB30RCR5UK

Hinge position: Right
Cream



FAB30LCR5UK

Hinge position: Left
Cream



FAB30RWH5UK

Hinge position: Right
White



FAB30LBL5UK

Hinge position: Left
Black



FAB30LWH5UK

Hinge position: Left
White



FAB30RPB5UK

Hinge position: Right
Pastel Blue



FAB30RPG5UK

Hinge position: Right
Pastel Green



FAB30RRD5UK

Hinge position: Right
Red



FAB30LPG5UK

Hinge position: Left
Pastel Green



FAB30RBL5UK









Hinge position: Right
Black



FAB30LRD5UK

Hinge position: Left
Red

Symbols glossary

	4 stars freezing compartment for better food preservation.		A+++: Appliances with this symbol can reduce energy consumption by a further 30% from the standard A energy rating.
	Energy efficiency class D		Ventilated: Forced distribution of cold air in the refrigerator compartment, which allows even temperature distribution within the fridge.
	LED interior lighting: is a more energy efficient and long lasting way of illuminating the interior of the appliance.		Life Plus 0°C: The temperature in the Lifeplus compartments is kept at 0°C, which preserves fresh meat and fish longer.
	Inverter technology: The evolution of Smeg's driers towards more intelligent and environmentally sustainable models has led to the choice of using Inverter technology with heat pumps, which reduces significantly energy consumption.		Air plus: keeps food fresher for longer.