

# FMI425X

Usable volume

25 l



Product Family

Microwave

Category

Built-in

Installation

Fully Built-in

Power supply

Electric

Cooking Method

Microwave with grill

Control

Electromechanical



## Controls

Display / Clock

1 a LED

Type of control setting

Control knobs / buttons

Opening

Mechanical button

No. of controls

1

Control knobs

Push-push

Controls colour

Steel effect

Buttons Colour

Steel effect

## Options



Timer

Electronic

Time-setting options

End cooking

End of cooking acoustic alarm

Yes

Controls Lock / Child Safety

Yes

Quick start option

Yes

## Technical Features



Cavity material

Stainless steel

Shelf positions

2

Shelves type

Rack

No. of lights

1

Light type

LED

Turntable

Yes

Turntable dimensions

31.5 cm

Light when door is opened

Yes

Grill - power

1000 W

Door opening

Side-opening

Total no. of door glasses

1

Safety Thermostat

Yes

Cooling system

Tangential

Microwave screen protection

Yes

Microwave stops when door is opened

Yes

Grill type	Quartz	Usable cavity space dimensions (HxWxD)	206x368x328 mm
		Microwave effective power	900 W

## Accessories Included







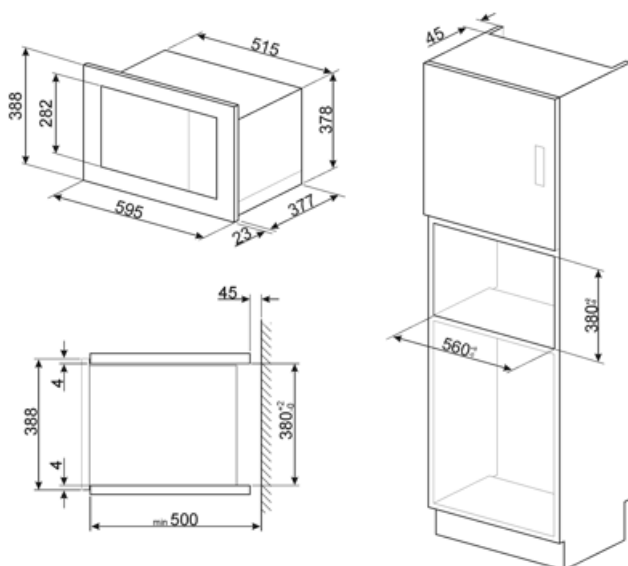



Grid	1
------	---

## Electrical Connection

Nominal power (W)	1450 W	Frequency (Hz)	50 Hz
Current	6.3 A	Power supply cable length	150 cm
Voltage (V)	230 V		



## Symbols glossary

-  Child lock: some models are fitted with a device to lock the programme/cycle so it cannot be accidentally changed.
-  Defrost by time: with this function the time of thawing of foods are determined automatically.
-  Fingerprint proof stainless steel: Fingerprint proof stainless steel keeps stainless steel looking as good as new.
-  Microwave: Penetrating straight into the food, microwaves cook very quickly and with considerable energy savings. Suitable for cooking without fat, they are also able to thaw and heat food without altering its original appearance and aroma. The microwave function can also be combined with conventional functions with all the resulting advantages. Ideal for all types of food.
-  Side lights: Two opposing side lights increase visibility inside the oven.
-  The capacity indicates the amount of usable space in the oven cavity in litres.
-  Microwave energy shortens cooking times dramatically and produces energy savings.
-  Defrost by weight: With this function the defrosting time is determined
-  Grill element: Using of grill gives excellent results when cooking meat of medium and small portions, especially when combined with a rotisserie (where possible). Also ideal for cooking sausages and bacon.
-  Microwave + grill element: The use of the grill results in a perfect browning of the surface of the food. The action of microwaves allows instead of cooking in a short time the internal part of the food.
-  The oven cavity has 2 different cooking levels.

---

## Benefit

---

### **Automatic programmes**

Preset programmes to simplify use and improve efficiency

### **Child control lock**

Thanks to the child safety lock, the microwave provides peace of mind for parents while improving overall safety in the home environment

### **Quick start**

One-touch cooking and heating start-up with the Quick Start option for a simple and intuitive user experience