

FQ60BDE



Product Family	Refrigerator
Installation	Free Standing
Category	4 Doors
Reference width	Higher than 80
Reference height	160 - 200
No-Frost system	Total
Cooling type	Total No Frost - Double Cooling system
Defrost	Automatic
Hinge type	Standard
EAN code	8017709337681



Aesthetics



Aesthetics	Universal	Side colour	White
Colour	White	Logo	Applied
Design	Flat	Door shelves profile colour	Silver
Material	Metal sheet	Drawers profile colour	Silver
Handle	External	Colour of glass shelf profile	Silver
Handle type	Fixed	Display	LED
Handle colour	Silver	Display position	External (on door)
Logo colour	Chrome	Colori disponibili	Stainless steel, Black
Side material	Steel		

Refrigerator compartment features

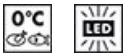

No. of adjustable shelves	2	Type of crisper/vegetable drawers cover	Glass
Number of fruit and vegetables drawers	2	No. of lights	2
Type of adjustable shelves	Glass	Life Plus zone-0°C	Yes
Type of crisper/vegetable drawers cover	On sliding rails	Internal light in fridge (fridge)	Yes
Crisper Cover	Yes		

Refrigerator Inner Door

No. of door shelves with transparent cover	2	No. of bottle shelves	2
Number of adjustable door shelves	2		

Other Refrigerator features



Accessories	Egg tray	MultiFlow	Yes
Natural Plus Blu Light	Yes	Fan	Yes

Freezer compartment features

Number of drawers	4	Type of shelves	Glass
No. of shelves	2		

Other Freezer features



Accessories	2 ice boxes	Fast freezing compartment	Yes
-------------	-------------	---------------------------	-----

Other technical features

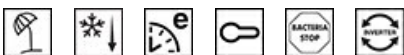

Functions display	Holiday, Fast freezing, Fast cooling, ECO, Control lock
Fast freezing button	Yes
Temperature alarm lamp	Yes
Door open alarm	Yes
Temperature Alarm	Yes
Antibacterial Gasket	Yes
Type of temperature control	Electronic
No. of compressors	1
Refrigerant gas type	R600a
Type of compressor	Variable Speed Compressor
Foam agent	Cyclopentane

Performance / Energy Label



Annual energy consumption	406 KWh/year	Noise level	37 dB(A) re 1 pW
Energy efficiency class	E	Thaw time	10 h
Airborne acoustical noise emission class	C	4 star - Freezing capacity	4.6 Kg/24h
Total volume	572 l		







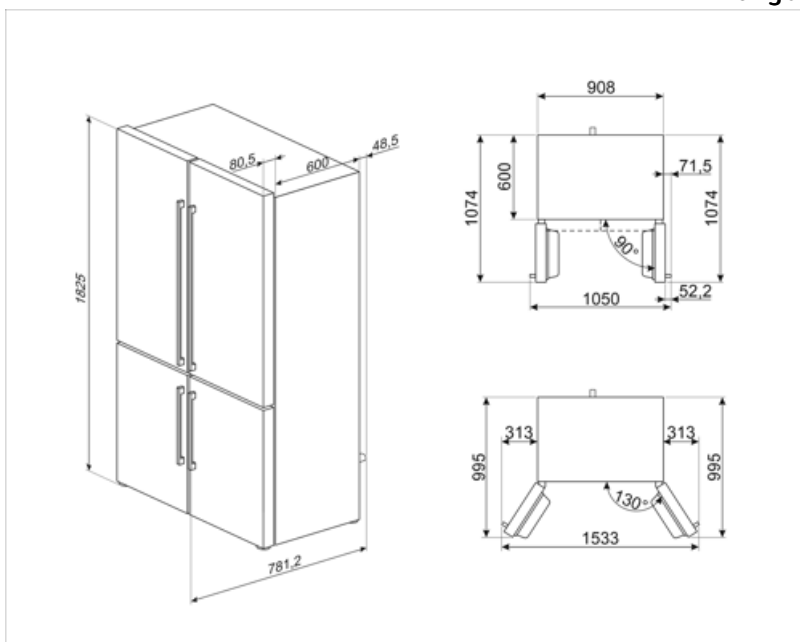







Sum of the volumes of the frozen compartment(s)	196 l	4 star - Freezing capacity	4.6 Kg/24h
Sum of the volumes of the chill compartment(s) and the unfrozen compartment(s)	376 l	Climatic class	SN, N, ST, T
		EEl	100 %

Electrical Connection

Plug	(F;E) Schuko	Voltage (V)	230 V
Nominal power	200 W	Frequency (Hz)	50 Hz
Current	0,8 A	Power supply cable length	240 cm



Symbols glossary

	The automatic defrost system works by automatically defrosting at regular intervals eliminating the need to defrost altogether.		Antibacterial treatment: antibacterial treatment to ensure better hygiene
	Child lock: some models are fitted with a device to lock the programme/cycle so it cannot be accidentally changed.		Energy efficiency class E
	LED display: to show programmes, functions and options selected and the time to the end of the cycle.		Economical mode: Analyzes fridge functioning during the activation and optimizes the operating cycle in order to reduce power consumption.
	Ventilated: Forced distribution of cold air in the refrigerator compartment, which allows even temperature distribution within the fridge.		Fast freezing: The fast freezing function brings the temperature of the compartment down when activated a few hours prior to usage.
	Power saving mode: The power saving mode allows you to disable the refrigerator and keep the freezer working.		LED interior lighting: is a more energy efficient and long lasting way of illuminating the interior of the appliance.
	Life Plus 0°C: The temperature in the Lifepus compartments is kept at 0°C, which preserves fresh meat and fish longer.		Inverter technology: The evolution of Smeg's driers towards more intelligent and environmentally sustainable models has led to the choice of using Inverter technology with heat pumps, which reduces significantly energy consumption.
	Air plus: keeps food fresher for longer.		Natural Plus Blu Light: This unique Natural Plus Blu Light system works with nature to increase the storage time of fruit and vegetables.