

# FQ960BL6



Product Family	Refrigerator
Installation	Free Standing
Category	4 Doors
Reference width	Higher than 80
Reference height	160 - 200
No-Frost system	Total
Cooling type	Total No Frost - Double Cooling system
Defrost	Automatic
EAN code	8017709341503



## Aesthetics



Aesthetics	Victoria	Side material	Steel
Colour	Black	Side colour	Glossy Black
Design	Flat	Logo	Applied
Material	Metal sheet	Door shelves profile colour	Silver
Handle	External	Drawers profile colour	Silver
Handle type	Fixed	Colour of glass shelf profile	Chrome
Handle colour	Chrome	Display	LED
Logo colour	Chrome	Display position	Interior (on the top)

## Refrigerator compartment features



No. of adjustable shelves	2	Type of crisper/vegetable drawers cover	Glass
Number of fruit and vegetables drawers	2	Life Plus zone-0°C	Yes
Type of adjustable shelves	Glass	Internal light in fridge	Yes
Type of crisper/vegetable drawers cover	Standard	Type of internal light (fridge)	LED
Crisper Cover	Yes		

## Refrigerator Inner Door

No. of door shelves with transparent cover	2	No. of bottle shelves	2
Number of adjustable door shelves	2		

## Other Refrigerator features



Accessories	Egg tray	MultiFlow Fan	Yes
Natural Plus Blu Light	Yes		

## Freezer compartment features

Number of drawers	4	Type of shelves	Glass
No. of shelves	2		

## Other Freezer features



Fast freezing compartment	Yes
---------------------------	-----

## Other technical features

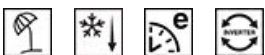

Functions display	Holiday, Fast freezing, Fast cooling, ECO
Fast freezing button	Yes
Door open alarm	Yes
Type of temperature control	Electronic
No. of compressors	1
Refrigerant gas type	R600a
Type of compressor	Variable Speed Compressor
Refrigerant Quantity (gr)	62 g
Foam agent	Cyclopentane

## Performance / Energy Label

			
Annual energy consumption	338 kWh/year	Noise level	37 dB(A) re 1 pW
Energy efficiency class	E	Thaw time	10 h
Airborne acoustical noise emission class	C	4 star - Freezing capacity	9 Kg/24h
Total volume	572 l	4 star - Freezing capacity	9 Kg/24h
		Climatic class	SN, N, ST, T
		EEl	100 %

Sum of the volumes of the frozen compartment(s) 196 l







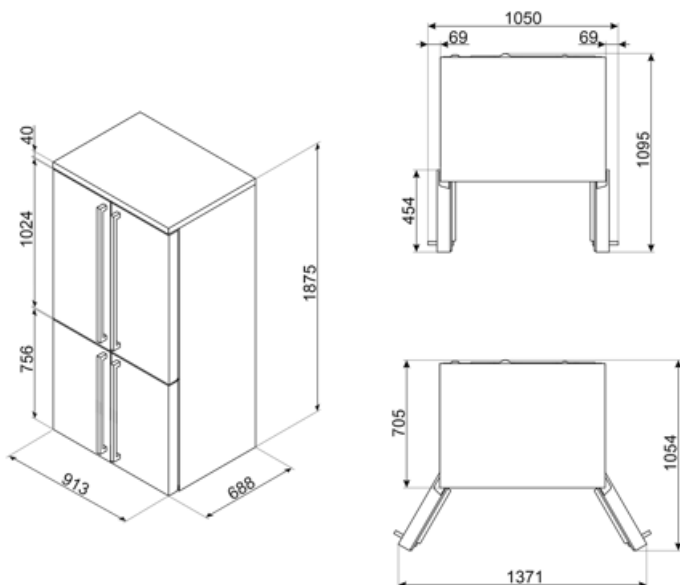





Sum of the volumes of the chill compartment(s) and the unfrozen compartment(s) 376 l

## Electrical Connection

Plug	(F;E) Schuko	Voltage (V)	220-240 V
Nominal power	200 W	Frequency (Hz)	50 Hz
Current	1.2 A	Power supply cable length	240 cm



## Symbols glossary

	4 stars freezing compartment for better food preservation.		The automatic defrost system works by automatically defrosting at regular intervals eliminating the need to defrost altogether.
	LED display: to show programmes, functions and options selected and the time to the end of the cycle.		Economical mode: Analyzes fridge functioning during the activation and optimizes the operating cycle in order to reduce power consumption.
	Ventilated: Forced distribution of cold air in the refrigerator compartment, which allows even temperature distribution within the fridge.		Fast freezing: The fast freezing function brings the temperature of the compartment down when activated a few hours prior to usage.
	Power saving mode: The power saving mode allows you to disable the refrigerator and keep the freezer working.		LED interior lighting: is a more energy efficient and long lasting way of illuminating the interior of the appliance.
	Life Plus 0°C: The temperature in the Lifeplus compartments is kept at 0°C, which preserves fresh meat and fish longer.		Inverter technology: The evolution of Smeg's driers towards more intelligent and environmentally sustainable models has led to the choice of using Inverter technology with heat pumps, which reduces significantly energy consumption.
	Air plus: keeps food fresher for longer.		Natural Plus Blu Light: This unique Natural Plus Blu Light system works with nature to increase the storage time of fruit and vegetables.
	Energy efficiency class E		