

FZU18LX



Product family	Freezers
Installation	Built-in
Category	One Door
Reference width	Until 60
Reference height	Higher than 200
Cooling type	No-frost
Hinge	Door-to-door
Hinge position	Left



Aesthetic

Aesthetics	Universal	Handle color	Stainless steel
Color	Stainless steel	Side material	Metal
Material	Stainless steel	Logo	Applied
Door stainless steel type	Normal	Drawers profile color	Silver
Handle	External	Display	TFT
Handle	Fixed		

Freezer features



Freezer lighting	Yes
Freezer lighting	LED
Number of drawers	3

Other Freezer features

Ice maker	Automatico
-----------	------------

Other technical features



Display functions	Holiday, Fast-freezing, MultiZone, Sabbath	Type of temperature control	Electronic
Fast-freezing button	Yes		

Power-on light	Yes
Temperature alarm light	Yes
Door-open alarm	Yes
Temperature Alarm	Yes
Antibacterial Gasket	Yes

No. of compressors	1
Refrigerant gas type	R600a
Type of compressor	Inverter
Refrigerant quantity	59 oz
Metal panel on the back of the fridge	Metal

Performance / Energy Label





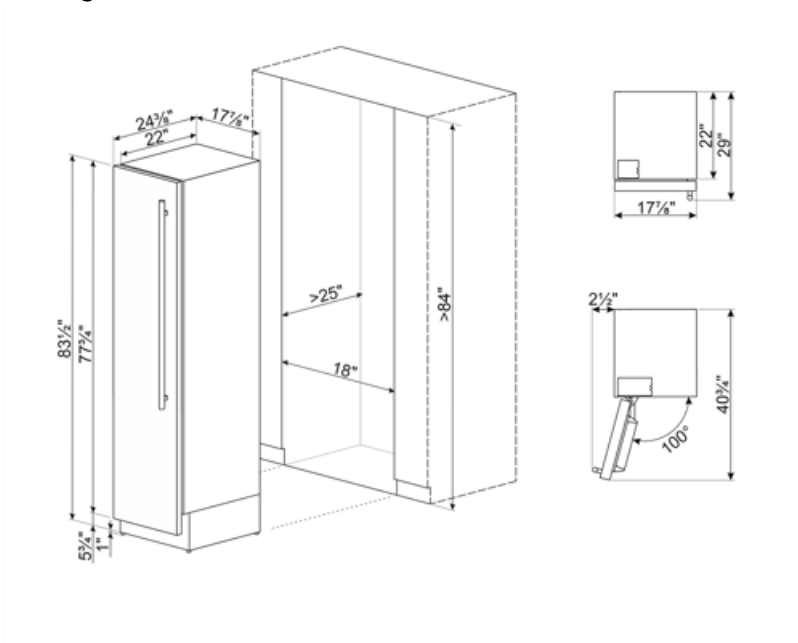

Total volume	61.3 gal	Climatic class	SN, N, ST, T
--------------	----------	----------------	--------------

Electrical Connection

Plug	(B) USA 120V	Frequency (Hz)	60 Hz
Current	2,4 A	Power cord length	78 3/4 "
Voltage	115 V		



Symbols glossary

- | | | | |
|--|---|---|---|
|  | <p>Fast freezing: The fast freezing function brings the temperature of the compartment down when activated a few hours prior to usage.</p> |  | <p>Power saving mode: The power saving mode allows you to disable the refrigerator and keep the freezer working.</p> |
|  | <p>LED interior lighting: is a more energy efficient and long lasting way of illuminating the interior of the appliance.</p> |  | <p>Inverter technology: The evolution of Smeg's driers towards more intelligent and environmentally sustainable models has led to the choice of using Inverter technology with heat pumps, which reduces significantly energy consumption.</p> |
|  | <p>Multizone: Multizone compartment can be used as a refrigerator or a freezer compartment. Depending on your needs and eating habits, you can select settings, program the temperature using.</p> |  | <p>No Frost: The No Frost and Frost free systems prevent ice from forming so that no defrosting is required.</p> |