

HOB182DG

Product Family	Hob
Built-in type	Ultra-low profile or Fully Flushed
Dimensions	80 cm
Power supply	Electric
Type	Induction with integrated hood
Extraction	Extraction
Electronic control	Yes
EAN code	8017709331856
Energy efficiency class (EEC)	A++



Aesthetics



Aesthetic	Linea
Colour	Neptune Grey
Finishing	Glass
Material	Glass
Glass type	Ceramic
Glass edge	Straight edge
Pan stands	Cast iron
Type of control setting	EVO Slider
Slider	Yes
LED colours	White
Control knob position	Front
Serigraphy colour	Grey

Programs / Functions



No. of induction cook zones	4
Time-setting options	Spegnimento automatico
No. of cooking zones with booster	4
No. of Flexible zones	2
Main on/off switch	Yes
Power levels	9
Total no. of cook zones	4

Options



Multizone Option	Yes	Residual time indicator	Yes
Flexible Zone Type	MultiZone	Limited Power	Si Advance
Worktop Cut-Out	482-483x765-766 mm	Consumption Mode	
Keep warm automatic function	Yes	Limited Power Consumption Mode in W	2800, 3500, 4500, 7400 W
End cooking timer	4	Showroom Demo Option	Yes
Pause option	Yes	Control Lock / Child Safety	Yes
Minute minder	1	Cleaning option	Yes
End of cooking alarm	Yes	Quick start	Yes
		Rapid level selection	Yes

Technical Features



Front-left - Induction - Multizone - 2.10 kW - Booster 3.00 kW - 21.0x19.0 cm

Rear-left - Induction - Multizone - 2.10 kW - Booster 3.00 kW - 21.0x19.0 cm

Rear-right - 2.10 kW - Booster 3.00 kW - 21.0x19.0 cm

Front-right - 2.10 kW - Booster 3.00 kW - 21.0x19.0 cm

Multizone left - Booster 3.70 kW - 39.0x21.0 cm

Multizone right - Booster 3.70 kW - 39.0x21.0 cm

Automatic setting according to pan dimension	Yes	Automatic switch off when overflow	Yes
pan detection	Yes, min 9 cm	Residual heat indicator	Yes
Permanent Automatic Pot Detection with indication of the relative control	Yes	Protection against accidental start up	Yes

Accessories Included

Other accessories	Extraction and Filtering (tubes and Charcoal filter) included
--------------------------	---

Electrical Connection

Plug	Not present	Type of electric cable supplied	Yes, Single and Double phase
Electrical connection rating (W)	7620 W	Frequency (Hz)	50/60 Hz
Current	33 A	Power supply cable length	120 cm
Voltage (V)	220-240 V	Terminal box	6 poles
Voltage 2 (V)	380-415 V		

Controls (hood)

Hood control setting	Touch control	Display	Yes
Led color	Bianco		

Programs / Functions (hood)

Delay function	Yes	Hood time setting	Delay
No. of speeds	8	Other options	Kit for Recirculation and Extraction included
Intensive speed	2		
Other functions	AUTOVENT	Automatic connection between integrated hood and hob	yes

Technical Features (Hood)

Free outlet maximum capacity	750 m ³ /h	Anti-grease filters	Inox
Motor power	220 W	Charcoal filters included	YES, regenerable
No. of filters	1	Filter replacement indicator	Yes

Performance / Energy Label (hood)

Fluid Dynamic Efficiency (FDE)	37,60	Airborne acoustical A-weighted sound Power Emission at maximum speed (SPEmax)	65 dBA
Fluid Dynamic Efficiency class (FDEC)	A	Airbourne acoustical A-weighted sound power emission at boost speed (SPEboost)	72 dBA
Lighting Efficiency (LE)	0,0 lux/W	Power Consumption in Off mode (Po)	0,49 W
Lighting Efficiency Class (LEC)	NA	Time increase factor (F)	0,6
Grease Filtering Efficiency (GFE)	85,1 %	Energy Efficiency Index	32,8
Grease Filtering Efficiency Class (GFEC)	B	Measured air flow rate at best efficiency point (Qbep)	328 m ³ /h
Air flow at mininum speed (Qmin)	245 m ³ /h	Measured air pressure at best efficiency point (Pbep)	540 Pa
Air flow at maximum speed (Qmax)	505 m ³ /h	Measured electric power input at best efficiency point (Wbep)	131 W
Air flow at boost speed (Qboost)	700 m ³ /h	Sound power level at highest setting (Lwa)	65 dBA
Airbourne acouistical A-weighted sound Power Emission at minimum speed (SPEmin)	51 dBA		

Speed 1

Extraction rate IEC 61591	245 m ³ /h
Noise level IEC 60704-2-13	51 dBA
Pressure	290 Pa
Power	35 W

Speed 2

Extraction rate IEC 61591	285 m ³ /h
Noise level IEC 60704-2-13	55 dBA
Pressure	370 Pa
Power	45 W

Speed 3

Extraction rate IEC 61591	350 m ³ /h
Noise level IEC 60704-2-13	57 dBA
Pressure	525 Pa
Power	65 W

Speed 4

Extraction rate IEC 61591	380 m ³ /h
Noise level IEC 60704-2-13	59 dBA
Pressure	530 Pa
Power	75 W

Speed 5

Extraction rate IEC 61591	410 m ³ /h
Noise level IEC 60704-2-13	62 dBA
Pressure	535 Pa
Power	85 W

Speed 6

Extraction rate IEC 61591	445 m ³ /h
Noise level IEC 60704-2-13	63 dBA
Pressure	540 Pa
Power	105 W

Speed 7

Extraction rate IEC 61591	475 m ³ /h
Noise level IEC 60704-2-13	64 dBA
Pressure	545 Pa
Power	115 W

Speed 8

Extraction rate IEC 61591	505 m ³ /h
Noise level IEC 60704-2-13	65 dBA
Pressure	550 Pa
Power	130 W

Intensive speed

Extraction rate (IEC 61591)	550 m ³ /h
Noise level IEC 60704-2-13	66 dBA
Pressure	555 Pa
Power	140 W

Intensive Speed 2

Extraction rate IEC 61591	700 m ³ /h
Noise level IEC 60704-2-13	72 dBA
Pressure	560 Pa
Power	220 W

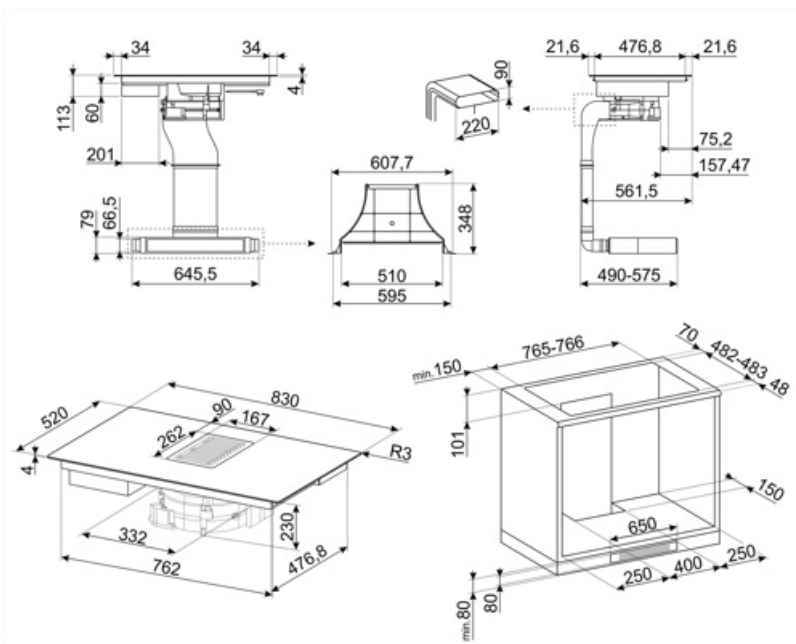

Not included accessories



CON60H

Flat duct connector for tubes 220*60 mm. It help to connect more tubes of the kit KITEHOBD4



FLTHOBD4

Charcoal Anti Odour Filter regenerable as spare part suitable for HOBD482D and HOBD182DG. Regenerable filter up to 5 times by washing it in dishwasher and drying into oven at max temperature of 70° for max 2 hours.



GRI60H

Rectangular Louvred grille, external size 246*80 mm and internal 226*60*50 mm



KITEHOBD4

Filtering kit (lateral outlet) optional for Hobd: tube 1,5 mt and curve, high 60 mm



KITF6HOBD

Recirculating kit for Hobd: tubes + regenerable anti-odor filter + grid in stainless steel with magnetics fix (easy to remove) that fit in a plinth of min. 6 cm. The ceramic filter can be regenerate up to 10 times by putting it inside the oven at 250° for 1 hour.



RED60H

















Reducer from 90 to 60 mm suitable for rectangular tube of 220 mm. Size: 220x90x92 mm



TPK

Stainless steel grill plate to cook Teppanyaki dishes

Symbols glossary

 <p>Permanent auto pot detection</p>	 <p>Power booster: option allows the zone to work at full power when very intense cooking is necessary.</p>
 <p>Heavy duty cast iron pan stands: for maximum stability and strength.</p>	 <p>Child lock: some models are fitted with a device to lock the programme/cycle so it cannot be accidentally changed.</p>
 <p>Evolution Slider totally Back-lighted ghost effect</p>	 <p>The slider control panel allows you to adjust the power simply by passing your finger across the touch device.</p>
 <p>This function allows you to keep cooked food warm without burner it</p>	 <p>Multizone: allows several pans to be used at once, large or small, offering freedom of placement and greater flexibility</p>
 <p>Overfill protection: The special overfill protection shuts down the stove in the presence of overflow of liquids.</p>	 <p>Min diameter pot detection of 9 cm</p>
 <p>All cooking zones can be reduced to the minimum power level, so the hob can be left unattended for a short period without food overcooking or burning. Then just press again this function, the previously set power levels can be reactivated.</p>	 <p>Possibility to set the maximum power absorption of the hob</p>
 <p>Quick selection, with one touch cooking begins at the highest level, then automatically reduces after time. Ideal for dishes that require quick boiling and then continued cooking without constant control (eg beef broth).</p>	 <p>Quick Start function: the chosen temperature is reached faster. The heating element works at maximum power until the right temperature is reached.</p>
 <p>Indication of residual heat: After the glass ceramic hob is switched off the residual heat indicator shows which of the heating zones still remains hot. When the temperature drops below 60 ° C, the indicator goes out.</p>	 <p>Time elapsed: shows how long the cooking zone has been in use.</p>
 <p>Timer: All ceramic hobs have a timer which automatically ends cooking after a preset time.</p>	