

HOB682D1

Product Family	Hob
Built-in type	Ultra-low profile or Fully Flushed
Dimensions	80 cm
Power supply	Electric
Type	Induction with integrated hood
Extraction	Extraction
Electronic control	Yes
EAN code	8017709298685
Energy efficiency class (EEC)	A+++



Aesthetics



Aesthetic	Universale
Colour	Black
Finishing	Glass
Material	Glass
Glass type	Ceramic
Glass edge	Straight edge
Pan stands	Cast iron
Type of control setting	Multi Slider
Slider	Yes
Control knob position	Front
Serigraphy colour	Grey

Programs / Functions



No. of induction cook zones	4
Time-setting options	Spegnimento automatico
No. of cooking zones with booster	4
No. of Flexible zones	2
Main on/off switch	Yes
Power levels	9
Auto-vent 2.0	Yes
Total no. of cook zones	2

Options

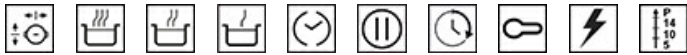

Multizone Option	Yes	Pause option	Yes
Flexible Zone Type	MultiZone	Minute minder	1
Worktop Cut-Out	482-483x765-766 mm	End of cooking alarm	Yes
Simmering Function	Yes	Residual time indicator	Yes
Keep warm automatic function	Yes	Control Lock / Child Safety	Yes
Melting/Low temperature cooking function	Yes	Quick start	Yes
End cooking timer	4	Rapid level selection	Yes

Technical Features



Left - Induction - Multizone - 2.10 kW - Booster 3.70 kW - 23.0x21.0 cm
 Right - Induction - Multizone - 2.10 kW - Booster 3.70 kW - 23.0x21.0 cm
 2.10 kW - Booster 3.70 kW - 23.0x21.0 cm
 2.10 kW - Booster 3.70 kW - 23.0x21.0 cm
 Multizone left - Booster 3.70 kW - 46.0x21.0 cm
 Multizone right - Booster 3.70 kW - 46.0x21.0 cm

Automatic setting according to pan dimension	Yes	Automatic switch off when overflow	Yes
pan detection	Yes	Residual heat indicator	Yes
Permanent Automatic Pot Detection with indication of the relative control	Yes	Protection against accidental start up	Yes

Electrical Connection

Plug	Not present	Type of electric cable supplied	Yes, Single and Double phase
Electrical connection rating (W)	7620 W	Frequency (Hz)	50/60 Hz
Current	33 A	Power supply cable length	120 cm
Voltage (V)	220-240 V	Terminal box	6 poles
Voltage 2 (V)	380-415 V		

Controls (hood)

Hood control setting	Touch Capacitive	Display	Yes
Led color	Bianco		

Programs / Functions (hood)

Delay function	Yes	Intensive speed	2
No. of speeds	8	Other functions	AUTOVENT

Technical Features (Hood)

Free outlet maximum capacity	750 m ³ /h	Anti-grease filters	Alluminio
Motor power	220 W	Filter replacement indicator	Yes
No. of filters	1		

Performance / Energy Label (hood)

Fluid Dynamic Efficiency (FDE)	40,30	Airborne acoustical A-weighted sound Power Emission at maximum speed (SPEmax)	65 dBA
Fluid Dynamic Efficiency class (FDEC)	A	Airbourne acoustical A-weighted sound power emission at boost speed (SPEboost)	72 dBA
Lighting Efficiency (LE)	0,0 lux/W	Power Consumption in Off mode (Po)	0,49 W
Lighting Efficiency Class (LEC)	NA	Time increase factor (F)	0,5
Grease Filtering Efficiency (GFE)	85,1 %	Energy Efficiency Index	27,5
Grease Filtering Efficiency Class (GFEC)	B	Measured air flow rate at best efficiency point (Qbep)	359 m ³ /h
Air flow at mininum speed (Qmin)	245 m ³ /h	Measured air pressure at best efficiency point (Pbep)	549 Pa
Air flow at maximum speed (Qmax)	505 m ³ /h	Measured electric power input at best efficiency point (Wbep)	136 W
Air flow at boost speed (Qboost)	700 m ³ /h	Sound power level at highest setting (Lwa)	65 dBA
Airbourne acouistical A-weighted sound Power Emission at minimum speed (SPEmin)	51 dBA		

Electrical Connections (hood)

Frequenza cappa	50-60 Hz
-----------------	----------

Speed 1

Extraction rate IEC 61591	245 m ³ /h
Noise level IEC 60704-2-13	51 dBA
Pressure	290 Pa
Power	35 W

Speed 2

Extraction rate IEC 61591	285 m ³ /h
Noise level IEC 60704-2-13	55 dBA
Pressure	370 Pa
Power	45 W

Speed 3

Extraction rate IEC 61591	350 m ³ /h
Noise level IEC 60704-2-13	57 dBA
Pressure	525 Pa
Power	60 W

Speed 4

Extraction rate IEC 61591	380 m ³ /h
Noise level IEC 60704-2-13	59 dBA
Pressure	530 Pa
Power	75 W

Speed 5

Extraction rate IEC 61591	410 m ³ /h
Noise level IEC 60704-2-13	62 dBA
Pressure	535 Pa
Power	85 W

Speed 6

Extraction rate IEC 61591	445 m ³ /h
Noise level IEC 60704-2-13	63 dBA
Pressure	540 Pa
Power	105 W

Speed 7

Extraction rate IEC 61591	475 m ³ /h
Noise level IEC 60704-2-13	64 dBA
Pressure	545 Pa
Power	115 W

Speed 8

Extraction rate IEC 61591	505 m ³ /h
Noise level IEC 60704-2-13	65 dBA
Pressure	550 Pa
Power	125 W

Intensive speed

Extraction rate (IEC 61591)	550 m ³ /h
Noise level IEC 60704-2-13	66 dBA
Pressure	555 Pa
Power	140 W

Intensive Speed 2

Extraction rate IEC 61591	700 m ³ /h
Noise level IEC 60704-2-13	72 dBA
Pressure	560 Pa
Power	220 W

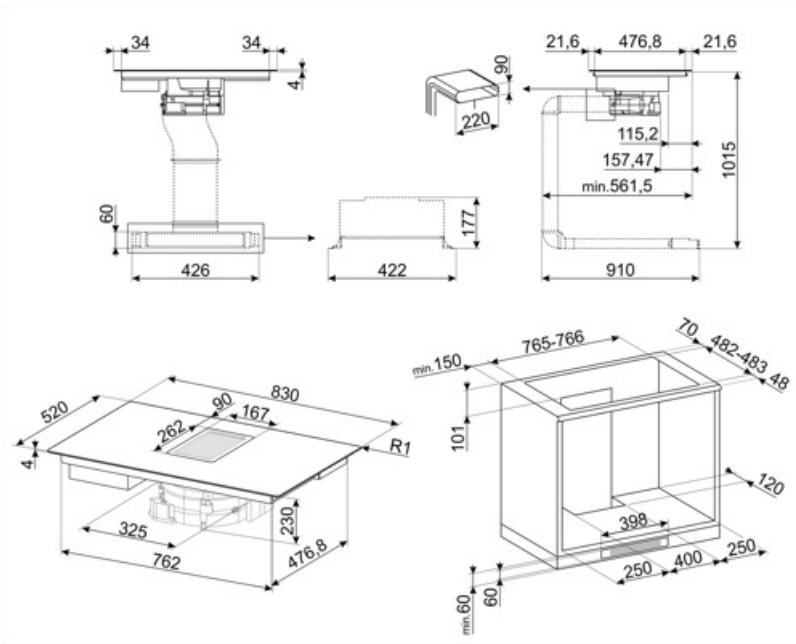

Not included accessories



CON60H

Flat duct connector for tubes 220*60 mm. It help to connect more tubes of the kit KITEHOBD4



GRI60H

Rectangular Louvred grille, external size 246*80 mm and internal 226*60*50 mm



KITEHOBD4

Filtering kit (lateral outlet) optional for Hobd: tube 1,5 mt and curve, high 60 mm



RED60H

Reducer from 90 to 60 mm suitable for rectangular tube of 220 mm. Size: 220x90x92 mm



FLTHOBD

Ceramic Anti Odour Filter regenerable as spare part suitable only for Recirculating kit (accessory KITF6HOBD) of the hob with integrated hood models. The anti-odor filter can be regenerated every 3 or 4 months depending on use and up to a maximum of 10 times, by placing it in the oven at 250° for an hour.



KITEHOBD

Exhaust kit optional for Hobd: tubes for installation in exhaust mode

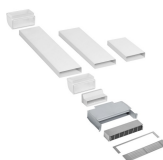

KITF6HOBD



















Recirculating kit for Hobd: tubes + regenerable anti-odor filter + grid in stainless steel with magnetics fix (easy to remove) that fit in a plinth of min. 6 cm. The ceramic filter can be regenerate up to 10 times by putting it inside the oven at 250° for 1 hour.



TPK

Stainless steel grill plate to cook Teppanyaki dishes

Symbols glossary

 <p>Permanent auto pot detection</p>	 <p>Connection between hob and hood</p>
 <p>Power booster: option allows the zone to work at full power when very intense cooking is necessary.</p>	 <p>Heavy duty cast iron pan stands: for maximum stability and strength.</p>
 <p>Child lock: some models are fitted with a device to lock the programme/cycle so it cannot be accidentally changed.</p>	 <p>The slider control panel allows you to adjust the power simply by passing your finger across the touch device.</p>
 <p>This function allows you to keep cooked food warm without burner it</p>	 <p>Melting function, suitable for slowly melting delicate foods such as chocolate or butter.</p>
 <p>Multizone: allows several pans to be used at once, large or small, offering freedom of placement and greater flexibility</p>	 <p>Overfill protection: The special overfill protection shuts down the stove in the presence of overflow of liquids.</p>
 <p>All cooking zones can be reduced to the minimum power level, so the hob can be left unattended for a short period without food overcooking or burning. Then just press again this function, the previously set power levels can be reactivated.</p>	 <p>Quick selection, with one touch cooking begins at the highest level, then automatically reduces after time. Ideal for dishes that require quick boiling and then continued cooking without constant control (eg beef broth).</p>
 <p>Quick Start function: the chosen temperature is reached faster. The heating element works at maximum power until the right temperature is reached.</p>	 <p>Indication of residual heat: After the glass ceramic hob is switched off the residual heat indicator shows which of the heating zones still remains hot. When the temperature drops below 60 ° C, the indicator goes out.</p>
 <p>Simmering function: ideal for long-cooking recipes, preventing food from boiling over or sticking to the pan.</p>	 <p>Time elapsed: shows how long the cooking zone has been in use.</p>
 <p>Timer: All ceramic hobs have a timer which automatically ends cooking after a preset time.</p>	 <p>Premium individual Slider control for each zone</p>