

KLT12L4WH



Familie	Afzuigkap
Type afzuigkap	Plafond unit
Design	Plafond unit
Filtering	Expulsie
Elektronische bediening	Ja
Randafzuiging	Ja
Materiaal	Roestvrij staal
Type roestvrijstaal	Geborsteld
EAN-code	8017709326197







Design

Esthetiek	Universeel	Afwerking	Geborsteld
Kleur	Matt White	Logo	Geëtst

Bediening

Regeling bediening	Touch control met wit achtergrond verlichting
--------------------	---

Program / Functions

Aantal snelheden	3
Snelheid Intensief	
Luchtzuiveringsfunctie (24 uur)	
Opties tijdprogrammering	
Auto-vent 2.0	

Technische specificaties



Aantal lampen	2	Vetfilters	Aluminium
Soort verlichting	LED	Indicator vervangen filter	Ja
Vermogen lamp	7.4 W		

Elektrische aansluiting

Aansluitwaarde	305 W	Frequentie	50-60 Hz
Spanning	220-240 V	Lengte voedingskabel	1500 mm

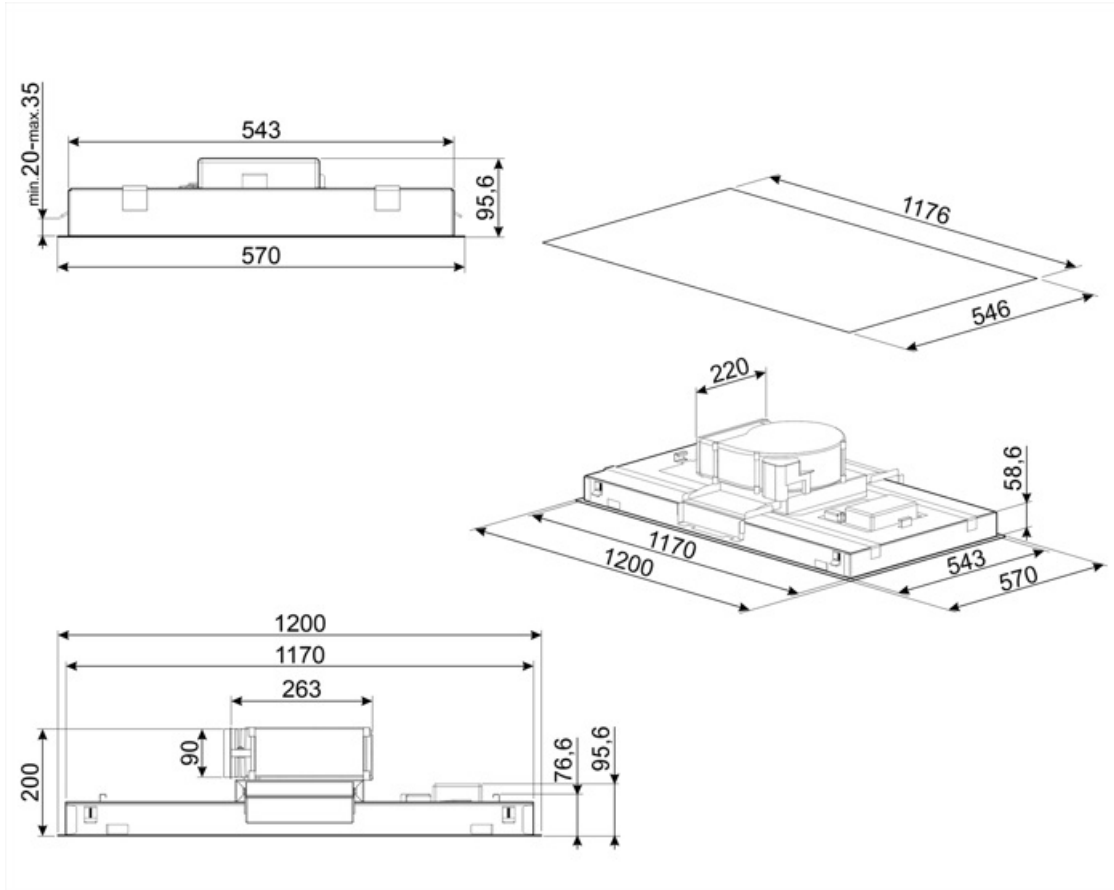

Accessoires niet inbegrepen



KITALLFC

Universele koolfilter Roestvrij staal AISI 304 Het filter kan in de vaatwasser op 50 °C worden gewassen (water en geschikt afwasmiddel) en om het te drogen in de oven op 180°C 25 minuten

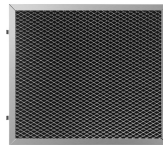

KITFCKLTR











1 pcs of Charcoal filter Regenerable* suitable for all the KLT* models. * It can be washed in the dishwasher up to 12 times and dry in the oven at max 90° for 60 min. dimension 235(H) x 200 (L) x 10 (D) mm



RRA90

Round to rectangular adapter 220x90 mm to 150 Ø

Symbols glossary

- | | | | |
|--|---|---|--|
|  | 24h: Indien geselecteerd, ververs deze functie de lucht voor c. 10 minuten per uur gedurende een periode van 24 uur, met minimale snelheid en een onmerkbaar geluidsniveau. |  | Filters: het model heeft filters die helpen bij het verwijderen van vet uit de stoom die tijdens het koken uit de pannen komt. |
|  | Automatisch uitschakelen: een speciale instelling om na het koken een vooraf ingestelde tijd te laten draaien en vervolgens automatisch uit te schakelen |  | Waarschuwingslampje (s): om aan te geven wanneer filters moeten worden vervangen. |
|  | Verlichting: Alle afzuigkappen hebben verlichting aan, om de kookzone te verlichten of voor sfeer in de keuken |  | Perimeter extraction panels: very efficient and aid noise reduction. |
|  | Intensieve / turbo-stand: wanneer extra snelle afzuiging gewenst is. |  | Connection between hob and hood |
|  | Tunable white from warm to cold |  | |