

KSG9P4MB



Product family	Hood
Hood Type	Integrated hood
Design	Fully integrated
Extraction	Extraction
Electronic control	Yes
Perimeter extraction	Yes
Material	Stainless steel
Type of steel	Brushed
EAN code	8017709336301







Aesthetics

Aesthetic Colour	Universale Matt Black	Finishing Logo	Satin Silk screen
------------------	--------------------------	----------------	----------------------

Controls

Control setting	Touch control back-lighted White	Led color	White
-----------------	-------------------------------------	-----------	-------

Programs / Functions

No. of speeds	3
Intensive speed	
24h air filter function	
Time-setting options	
Auto-vent 2.0	

Technical Features

    	No. of lights	2	No. of filters	2
	Light type	LED	Anti-grease filters	Aluminium
	Light Power	2.3 W		
	Dimmer mode	Yes		

Light color temperature range	2700° - 4000° °K	Filter replacement indicator	Yes
Free outlet maximum capacity	730 m³/h	Vent outlet	150 mm
Motor power	230 W	Minimum distance from GAS hob	650 mm
		Minimum distance from ELECTRIC hob	650 mm
		Non return valve	Yes

	Extraction rate IEC 61591 [m³/h]	Noise level IEC 60704-2-13 [dBA]
Speed 1	243	45
Speed 2	362	53
Speed 3	481	59
Intensive speed	697	67

Performance / Energy Label



Annual Efficiency Consumption (AEChood)	53 kWh/a	Airborne acoustical A-weighted sound Power Emission at maximum speed (SPEmax)	60 dBA
Energy efficiency class (EEC)	A	Airbourne acoustical A-weighted sound power emission at boost speed (SPEboost)	67 dBA
Fluid Dynamic Efficiency (FDE)	30,1	Power Consumption in Off mode (Po)	0,49 W
Fluid Dynamic Efficiency class (FDEC)	A	Time increase factor (F)	0,9
Lighting Efficiency (LE)	31,1 lux/W	Energy Efficiency Index	52,6
Lighting Efficiency Class (LEC)	A	Measured air flow rate at best efficiency point (Qbep)	369 m³/h
Grease Filtering Efficiency (GFE)	77,9 %	Measured air pressure at best efficiency point (Pbep)	446 Pa
Grease Filtering Efficiency Class (GFEC)	C	Measured electric power input at best efficiency point (Wbep)	152 W
Air flow at minumum speed (Qmin)	242 m³/h	Nominal Power consumption of the light system (WL)	5 W
Air flow at maximum speed (Qmax)	481 m³/h	Average illumination of the light on the cooking surface (Emiddle)	143 lux
Air flow at boost speed (Qboost)	697 m³/h	Sound power level at highest setting (Lwa)	60 dBA
Airbourne acoustical A-weighted sound Power Emission at minimum speed (SPEmin)	45 dBA		

Electrical Connection

Plug	Not present	Frequency (Hz)	50-60 Hz
Electrical connection rating	235 W	Power supply cable length	1500 mm
Voltage	220-240 V		

Also available

Alternative colours available	Stainless steel	Available colours	KSG9P4X
-------------------------------	-----------------	-------------------	---------

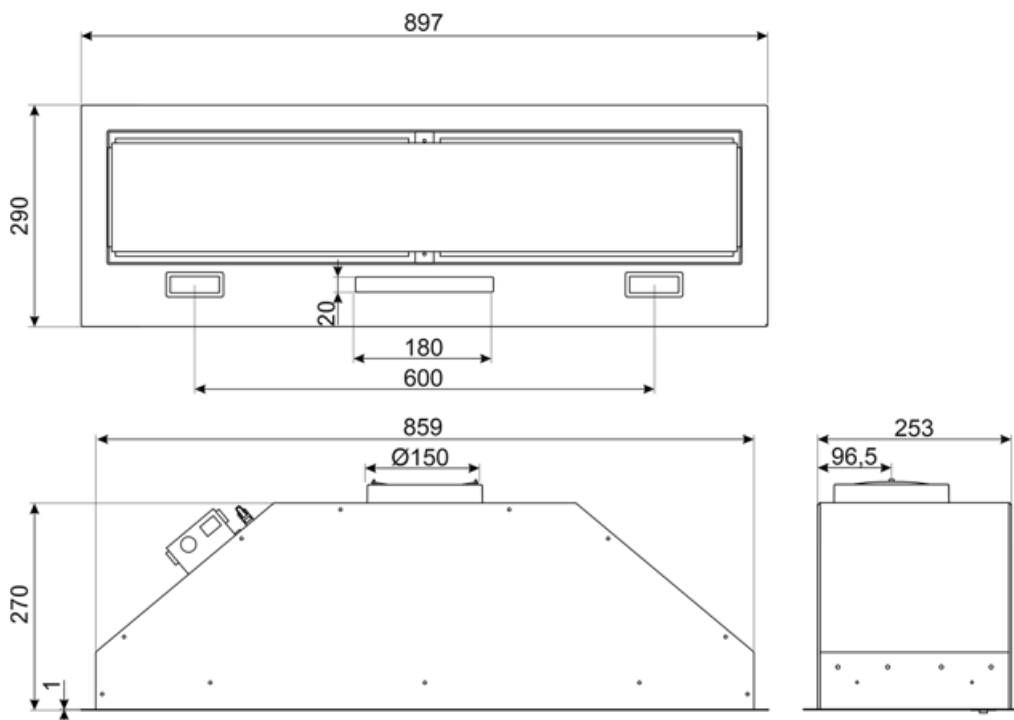

Not included accessories

FLT6











Round Charcoal filters (kit 2 pieces)



KITALLFC

Universal Charcoal filter Stainless Steel AISI 304 The filter can be washed in dishwasher 50 °C (water and suitable detergent) and to dry it put in the oven 180°C 25 minutes

Symbols glossary

	24h: When selected this function refreshes the air for c. 10 minutes every hour over a 24 hour period, at minimum speed and an imperceptible noise level.		Filters: Model has filters to help remove grease from the steam emanating from the pans during cooking.
	Connection between hob and hood		Switch off automatically: A special setting, to run after the end of cooking for a pre-set time and then switch off automatically.
			Dimmering Lights
	Warning light(s): to advise when filters need changing.		Lights: All cooker hoods feature lights to illuminate the cooking area or add to the ambience of the kitchen.
	Perimeter extraction panels: very efficient and aid noise reduction.		Intensive/turbo setting: when extra fast extraction is required.
	Tunable white from warm to cold		