

# LSP324BQX



<b>Product Family</b>	Dishwashers
<b>Commercial width</b>	60 cm
<b>Commercial height</b>	82 cm
<b>Installation</b>	Under counter built-in
<b>N° baskets</b>	3, FlexiDuo
<b>Motor</b>	Inverter 2.0
<b>EAN code</b>	8017709305130



## Programs



<b>N. of programmes</b>	10+1	<b>Auto sensor 45-65</b>	Yes
<b>Washing temperatures</b>	38, 45, 50, 55, 65, 70, 75 °C	<b>Mix</b>	Yes
<b>Soak</b>	Yes	<b>Quiet (-2 dB)</b>	Yes
<b>Express 27'</b>	Yes	<b>Intense</b>	Yes
<b>Crystal</b>	Yes	<b>Self clean</b>	Yes
<b>Full express - 60 minutes</b>	Yes	<b>Hygiene 99,9%</b>	Yes
<b>ECO</b>	Yes		

## Options



<b>Dry Assist+ option</b>	Yes	<b>1/2 load FlexiZone option</b>	Yes
<b>Delay timer option</b>	Up to 24 hours	<b>Special programs option</b>	Yes

## Baskets



<b>Basket colour</b>	Grey	<b>Largest loadable dish in upper basket</b>	19,0 cm
<b>Basket components colour</b>	Grey	<b>Lower Basket</b>	With 4 foldable racks
<b>Handle</b>	In plastic on upper and lower basket	<b>Lower basket with anti-drip inserts</b>	Yes

<b>Upper Basket</b>	With 3 foldable racks	<b>Largest loadable dish in lower basket</b>	30,0 cm
<b>Glass holder</b>	Yes	<b>Colour Inner Components</b>	Blue
<b>Height adjustment of the upper basket</b>	On three levels (5 cm)	<b>Cutlery basket</b>	Yes
<b>Sliding Guides Extra Glide</b>	Yes		

## Technical Features



<b>Width (mm)</b>	598 mm	<b>Flood protection system</b>	Total Acquastop
<b>Depth (mm)</b>	570 mm	<b>Water supply</b>	Single; cold/hot water max. 60°C - energysave with hot water up to 35%
<b>Display type</b>	LED (external)	<b>Max water hardness</b>	100°FH;58°dH
<b>Product Height (mm)</b>	818 mm	<b>Drying system</b>	Natural condenser drying, with Dry Assist + automatic door opening system at the end of the cycle
<b>Controls</b>	Electronic	<b>Steam protection</b>	In plastic
<b>Display</b>	Delayed start, Programme time indicator, Time to end indication	<b>Tube material</b>	Stainless steel
<b>Programme graphics</b>	Symbols	<b>Filter</b>	Stainless steel
<b>On/off indicator</b>	Yes	<b>Concealed heating element</b>	Yes
<b>Salt light indicator</b>	Light	<b>Hinges</b>	Self balancing with variable hinges
<b>Rinse aid indicator</b>	Light	<b>Min. and max plinth height</b>	100 - 170 mm
<b>Progress indicator</b>	Yes	<b>Adjustable feet</b>	7cm, from 820 to 890 mm
<b>End of cycle indicator</b>	On display, with acoustic signal	<b>Additional gaskets</b>	Yes, with stainless steel plate
<b>Washing system</b>	Planetarium	<b>Back cover</b>	Yes
<b>Third spray arm</b>	Single	<b>Depth of dishwasher with open door (mm)</b>	1146
<b>Water softener</b>	With electronic setting	<b>Back feet adjustable from front</b>	Yes
<b>Turbidity sensor Aquatest</b>	Yes	<b>Top cover</b>	In plastic

## Performance / Energy Label - Reg. 2019

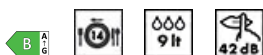

<b>Energy Efficiency Class</b>	B	<b>Programme duration</b>	4:25 h:min
<b>Energy consumption [per 100 cycles, based on the eco programme]</b>	64 kWh	<b>Airborne acoustical noise emissions</b>	42 dB(A) re 1 pW
<b>Rated capacity (ps)</b>	14	<b>Airborne acoustical noise emission class</b>	B
<b>Water consumption [per cycle]</b>	9.0 litres	<b>Energy efficiency Index (EEI)</b>	37.8

## Electrical Connection

<b>Plug</b>	(F;E) Schuko	<b>Frequency (Hz)</b>	50 Hz
<b>Connected power</b>	1800 W	<b>Type of connection</b>	Single-phase
<b>Current</b>	10 A	<b>Power supply cable length</b>	140 cm
<b>Voltage</b>	220-240 V		

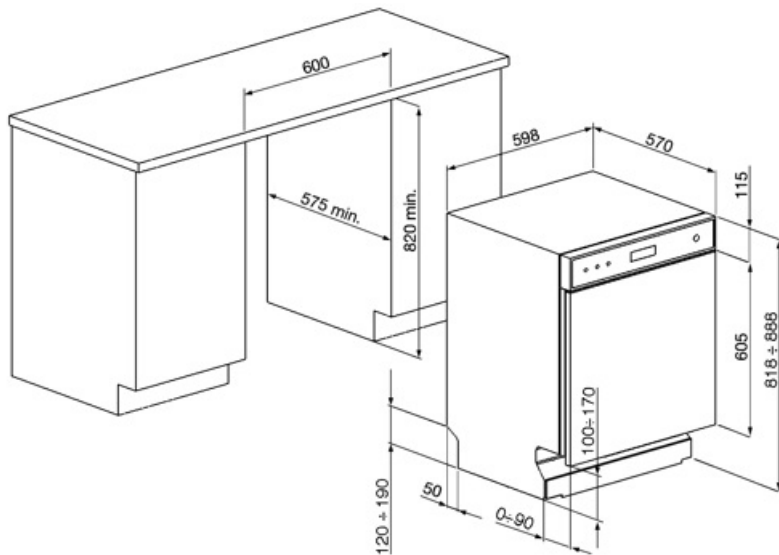

---

## Not included accessories

---

### KITGH

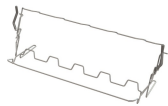

Kit glass holder. It has to be fitted on the first basket but only if there are foldable racks

### KITPL60N



Toekick Kit in Black colour with adjustable height and deepness. Can be installed over all the fully integrated and underbench models with variable fulcrum or flexifit hinges.

### KITPLV2



Kit extension for dishwasher and washing machine: lenght mt. 2

### KITPL60B























Toekick Kit in White colour with adjustable height and deepness. Can be installed over all the fully integrated and underbench models with variable fulcrum or flexifit hinges.









### KITPL60X



Toekick Kit in Stainless Steel with adjustable height and deepness. Can be fitted over all the fully integrated and underbench models with variable fulcrum or flexifit hinges.

## Symbols glossary

	<p>The Aquatest sensor is an electronic sensor that measures the degree of water transparency at the end of the initial soaking phase. Used on the values measured, the sensor sets the most suitable programme, thus obtaining the best washing results with the minimum amount of water.</p>		<p>To improve the drying of dishes without leaving stains.</p>
	<p>Energy efficiency class B</p>		<p>82 cm high</p>
	<p>Delay Timer: Option to postpone the start of the desired programme by up to 24 hours in order to programme the dishwasher to run at the desired time.</p>		<p>LED display: to show programmes, functions and options selected and the time to the end of the cycle.</p>
	<p>The Dry Assist + option, in addition to saving energy, ensures perfect drying of the dishes by opening the door automatically at the end of the washing cycle.</p>		<p>FlexiDuo: The FlexiDuo 3rd cutlery basket allows you to arrange cutlery or small cups, ladles, or bulky utensils however you like: it consists of two separate and moveable modules.</p>
	<p>FlexiZone: The 1/2 load flexizone allows you to wash a reduced load saving energy, water and time and there are no restrictions on where the items are placed.</p>		<p>The ExtraGlide guides system makes the second basket run even smoother and softer. It facilitates movement even when fully loaded, and thanks to the increased excursion, facilitates the insertion of dishes into the basket.</p>
	<p>Noise Level: Excellent insulation and special devices keep noise to a minimum.</p>		<p>The Planetary washing system, with high rotations per minute, guarantees complete coverage of the tank, thanks to the simultaneous rotation of base and sprayers, and excellent washing results.</p>
	<p>Auto 45°- 65°: The auto programme regulates the length of a cycle depending on the need for a pre-wash and the number of rinses required.</p>		<p>Crystals: The Crystals programme is dedicated to delicate dishes such as glasses and china.</p>
	<p>Eco: Eco, this economic wash programme uses a low amount of water and energy in order to provide the most environmentally friendly cleaning option.</p>		<p>Mix: The Mix programme is suitable for mixed crockery and everyday pots and pans, without any particular incrustation.</p>
	<p>Soak programme: The soak programme provides a rinse to prevent dirt from drying.</p>		<p>Express 27': The Express 27' programme is a quick wash cycle, at low temperatures, for lightly soiled dishes.</p>
	<p>Quick wash cycle for normally soiled mixed loads such as dishes and pans, even with dried-on residues. Dishes are washed and dried in 60 minutes.</p>		<p>Ultraclean: The Ultraclean option performs a final rinse at a high temperature of 70°C eliminating virtually all bacteria.</p>

- 
- |  |  |
|--|--|
|  14 place settings: Number of place settings.  |  Total Acquastop: In addition to the partial Acquastop protection present in all Smeg dishwashers, some models have an electronic device fitted to the water intake hose, which monitors water levels in the machine, detects leaks in the hose and switches off the water supply immediately when necessary. |
|  System WaterSave ensures the best washing results with minimal water consumption depending on the model of dishwasher.  |  Dishwasher cleaning cycle. The cycle should be started with the machine empty, without dishes. It is recommended to run the program every 2-3 months, using special dishwasher detergents.   |
|  SILENT: Wash cycle suitable for normally soiled dishes, even with dried-on residues. Ensures maximum noise reduction and is therefore ideal if you wish to run it during the night. |  Allows you to enable additional programs when selected together with any wash cycle. After having selected the required wash cycle, press the button (   |
|  HYGIENE 99.9% High-temperature washing programme. The 75° rinse guarantees the removal of 99.9% of germs and bacteria.  |  The work aimed at continuous improvement has allowed the creation of the second generation of the Inverter motor 2.0, characterised by greater efficiency and durability over time, which allows very high performance and a lower energy consumption and noise level.                                       |

## Benefit (TT)

---

### FlexiDuo

The flexible third basket provides additional space, adapting to the load to accommodate various types of dishes, ensuring optimal organization and efficient use of interior capacity

The third FlexiDuo basket consists of two separate sections that can be handled independently of each other, stacked and/or removed, offering loading flexibility for every need. Depending on the arrangement, it allows cups, tall glasses, bulky utensils and pots and pans to be placed in the upper basket.

### Planetarium Wash System

Full and deep wash coverage thanks to the advanced movement of the spray arm, an innovation patented by Smeg

Smeg's patented Planetarium Wash System guarantees impeccable cleaning. With a simultaneous double movement of the sprayer and 65 rotations per minute, it reaches every nook and cranny for extraordinary results. Dishes, glasses and utensils will be perfectly clean in no time. An intelligent system where efficiency and style meet, delivering brilliant results effortlessly.

### Extra Glide Telescopic Guides

Smoother and more stable loading and unloading operations

Extra Glide telescopic guides ensure smooth and safe extraction of the upper basket, even with heavy loads. The telescopic design ensures smooth, stable and silent movement, improving ergonomics and convenience. Ideal for optimising space and ease of use, they combine durability and comfort in every washing operation.

### DryAssist+

The Dry Assist+ system of automatic door opening at the end of the cycle ensures fast and energy-efficient drying