

LVS262EB



Product Family	Dishwashers
Commercial width	60 cm
Commercial height	85 cm
Installation	Free-standing
N° baskets	2
Motor	Inverter 2.0
EAN code	8017709334093



Programs

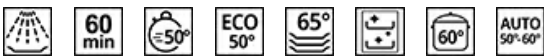

N. of programmes	8	Mix	Yes
Washing temperatures	50, 60, 65, 70 °C	Self clean	Yes
Soak	Yes	Intense 60°	Yes
Full express - 60 minutes	Yes	Mix 60°	
Express 50°	Yes	Auto 50°-60°	Yes
ECO	Yes		

Options



Delay timer option	Up to 24 hours	Crystal option	Yes
Extreme option	Yes	Sterilise option	Yes

Baskets

Basket colour	Grey	Lower Basket	With fixed racks
Basket components colour	Grey	Largest loadable dish in lower basket	31.0 cm
Upper Basket	With central fixed racks	Colour Inner Components	Grey
Height adjustment of the upper basket	On two levels (4 cm)	Cutlery basket	Yes
Largest loadable dish in upper basket	20,0 cm		

Technical Features



Width (mm)	598 mm	Water softener	With electronic setting
Depth (mm)	600 mm	Turbidity sensor Aquatest	Yes
Display type	LED display	Water supply	Single; cold/hot water max. 60°C - energysave with hot water up to 35%
Product Height (mm)	848 mm	Max water hardness	90°FH; 50°dH
Controls	Electronic	Drying system	Natural condenser drying, with Dry Assist automatic door opening system at the end of the cycle
Display	Delayed start, Programme time indicator, Time to end indication	Tube material	Stainless steel
Programme graphics	Symbols	Filter	Stainless steel
Salt light indicator	Light	Concealed heating element	Yes
Rinse aid indicator	Light	Hinges	Self balancing with fixed hinges
Progress indicator	Yes	Adjustable feet	Just for levelling
End of cycle indicator	On display, with acoustic signal	Depth of dishwasher with open door (mm)	1146
Washing system	Standard	Removable top	Yes
Third spray arm	Single	Top cover	In plastic

Performance / Energy Label - Reg. 2019



Energy Efficiency Class	E	Programme duration	4:00 h:min
Energy consumption [per 100 cycles, based on the eco programme]	94 KWh	Airborne acoustical noise emissions	46 dB(A) re 1 pW
Rated capacity (ps)	13	Airborne acoustical noise emission class	C
Water consumption [per cycle]	9,9 litres	Energy efficiency Index (EEI)	55,9

Electrical Connection

Plug	(F;E) Schuko	Frequency (Hz)	50 Hz
Connected power	1950 W	Type of connection	Single-phase
Current	10 A	Power supply cable length	150 cm
Voltage	220-240 V		

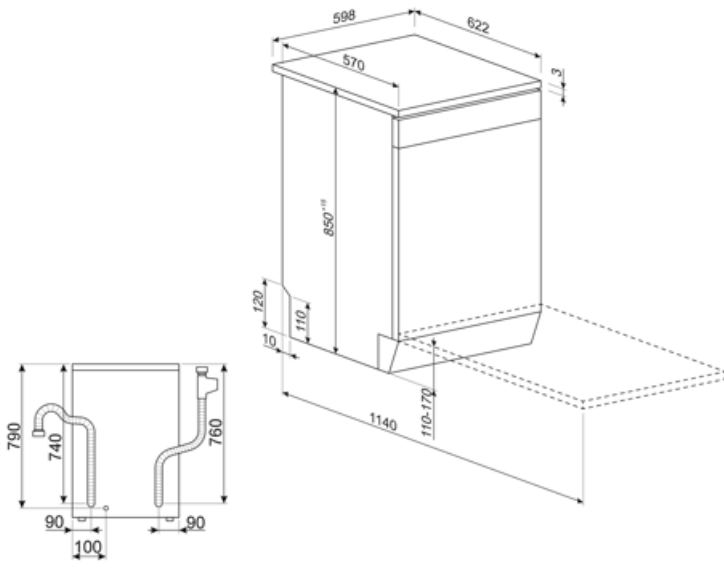

Compatible Accessories

KITINC

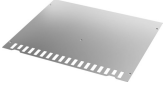



















KITPLV2



Kit extension for dishwasher and washing machine: lenght mt. 2

Symbols glossary

	<p>The Aquatest sensor is an electronic sensor that measures the degree of water transparency at the end of the initial soaking phase. Based on the values measured, the sensor sets the most suitable programme, thus obtaining the best washing results with the minimum amount of water.</p>		<p>Delay Timer: Option to postpone the start of the desired programme by up to 24 hours in order to programme the dishwasher to run at the desired time.</p>
	<p>Noise Level: Excellent insulation and special devices keep noise to a minimum.</p>		<p>Eco: Eco, this economic wash programme uses a low amount of water and energy in order to provide the most environmentally friendly cleaning option.</p>
	<p>Mix: The Mix programme is suitable for mixed crockery and everyday pots and pans, without any particular incrustation.</p>		<p>Soak programme: The soak programme provides a rinse to prevent dirt from drying.</p>
	<p>13 place settings: Number of place settings.</p>		<p>A quick programme suitable for washing a load with fresh and light soil.</p>
	<p>Quick wash cycle for normally soiled mixed loads such as dishes and pans, even with dried-on residues. Dishes are washed and dried in 60 minutes.</p>		<p>Dishwasher cleaning cycle. The cycle should be started with the machine empty, without dishes. It is recommended to run the program every 2-3 months, using special dishwasher detergents.</p>
	<p>Wash cycle for normally soiled mixed loads such as dishes and pans, even with dried-on residues. When this program is selected, the dishwasher recognises the type of dirt and automatically adjusts the washing parameters as appropriate.</p>		<p>This option provides special care for a delicate load. It prevents rapid changes in the wash temperature of the selected programme and reduces it to 4</p>
	<p>Programme suitable for washing and drying heavily soiled items with encrusted residues.</p>		<p>Option which improves the washing results of the selected programme. It increases the wash temperature and duration.</p>
	<p>Option which provides better cleaning results by keeping the temperature between 65 and 70°C for at least 10 minutes during the last rinsing phase.</p>		<p>Energy efficiency class E</p>
	<p>System WaterSave ensures the best washing results with minimal water consumption depending on the model of dishwasher.</p>		<p>The work aimed at continuous improvement has allowed the creation of the second generation of the Inverter motor 2.0, characterised by greater efficiency and durability over time, which allows very high performance and a lower energy consumption and noise level.</p>